

Aberystwyth University

Adaptive fuzzy interpolation

Yang, Longzhi; Shen, Qiang

Published in:

IEEE Transactions on Fuzzy Systems

DOI:

[10.1109/TFUZZ.2011.2161584](https://doi.org/10.1109/TFUZZ.2011.2161584)

Publication date:

2011

Citation for published version (APA):

Yang, L., & Shen, Q. (2011). Adaptive fuzzy interpolation. *IEEE Transactions on Fuzzy Systems*, 19(6), 1107-1126. <https://doi.org/10.1109/TFUZZ.2011.2161584>

General rights

Copyright and moral rights for the publications made accessible in the Aberystwyth Research Portal (the Institutional Repository) are retained by the authors and/or other copyright owners and it is a condition of accessing publications that users recognise and abide by the legal requirements associated with these rights.

- Users may download and print one copy of any publication from the Aberystwyth Research Portal for the purpose of private study or research.
- You may not further distribute the material or use it for any profit-making activity or commercial gain
- You may freely distribute the URL identifying the publication in the Aberystwyth Research Portal

Take down policy

If you believe that this document breaches copyright please contact us providing details, and we will remove access to the work immediately and investigate your claim.

tel: +44 1970 62 2400
email: is@aber.ac.uk

Adaptive Fuzzy Interpolation

Longzhi Yang, *Student Member, IEEE*, and Qiang Shen

Abstract—Fuzzy interpolative reasoning strengthens the power of fuzzy inference by enhancing the robustness of fuzzy systems and reducing systems complexity. However, after a series of interpolations, it is possible that multiple object values for a common variable are inferred, leading to inconsistency in interpolated results. Such inconsistencies may result from defective interpolated rules or incorrect interpolative transformations. This paper presents a novel approach for identification and correction of defective rules in interpolative transformations, thereby removing the inconsistencies. In particular, an assumption-based truth maintenance system is used to record dependencies between interpolations, and the underlying technique that the classical general diagnostic engine employs for fault localization is adapted to isolate possible faulty interpolated rules and their associated interpolative transformations. From this, an algorithm is introduced to allow for the modification of the original linear interpolation to become first-order piecewise linear. The approach is applied to a realistic problem, which predicates the diarrheal disease rates in remote villages, to demonstrate the potential of this work.

Index Terms—Fuzzy rule interpolation, assumption-based truth maintenance, general diagnostic engine.

I. INTRODUCTION

Fuzzy rule interpolation significantly improves the robustness of fuzzy reasoning. It provides a way to reduce the complexity of fuzzy systems by omitting those rules which can be approximated by their neighboring ones. Also, it improves the applicability of fuzzy systems by allowing a certain conclusion to be generated even if the existing rule base does not cover a given observation. A number of important interpolating approaches have been presented in the literature, including [9], [12], [13], [31], [36], [37], [38], [42], [43], [44], [45], [54], [56], [60], [63], [64].

Common to these fuzzy interpolation techniques is the fact that interpolation is carried out in a linear manner. However, this is not always feasible when dealing with realistic problems and hence, may lead to inconsistencies in inferred rules and reasoning results after a sequence of interpolations. This paper, based on the initial work of [66], [67], proposes a novel approach for finding and correcting faults in fuzzy interpolation. This is accomplished by: i) a diagnostic system that is implemented using the classical candidate generation procedure of General Diagnostic Engine (GDE) [21], by exploiting the inconsistent interpolative results recorded in an Assumption-based Truth Maintenance System (ATMS) [18]; and ii) a corrective system that is developed from the fuzzy extension of the conventional numerical interpolation theory [17] and its application in approximate computation [46], [50].

In order to derive a logically consistent result, the reasoning machine must be able to: 1) make assumptions and derive a result from these assumptions; and 2) subsequently revise these assumptions, and accordingly the results based on these assumptions, when contradiction appears. The truth maintenance system (TMS) aims to support reasoning machines to achieve this goal. Two primary approaches to TMS implementation have been proposed in the literature: the JTMS (justification-based TMS) [23] and the ATMS [18], [19], [20]. ATMS is capable of efficiently keeping track of all the dependent relations amongst logical deductions while JTMS only keeps track of one dependent relation for each logical deduction at a time. Especially, there is a specific logical deduction “false” in ATMS that keeps track of all the inconsistent assumption sets.

GDE is a system for isolation of multiple simultaneous faults, which was originally designed to find faults in physical domains, via the use of an ATMS. Each set of the multiple simultaneous faults in GDE is called a candidate. GDE generates all the possible candidates by exploring the dependencies of the special logical deduction “false” recorded by the ATMS. Because all the possible candidates need to be addressed, that is every set of inconsistent assumptions needs to be explored, ATMS is therefore utilized for efficiency purposes. By artificially viewing the interpolative inference procedure as a component with respect to each pair of rules that are used to perform the interpolation, possible candidates that may have led to detected inconsistencies can be generated by adapting the GDE. Note that theoretically, inconsistency may indicate contradictions of original observations or failure of rules. As an initial research in this area, this paper focuses on inconsistencies that are caused by interpolated rules while assuming that given observations and rules are true. In particular, ATMS records the dependencies between an interpolated value and its proceeding fuzzy interpolative reasoning components. From this, GDE works out all possible candidates from those sets of contradictory dependent components. Finally, such located fault candidates are corrected by a dependency-guided modification algorithm which modifies defective fuzzy reasoning components by means of refinement of these components from linear interpolation to piecewise linear interpolation. The overall approach is outlined in Fig. 1.

The rest of this paper is structured as follows. Section II presents the relevant background, outlining the scale and move transformation-based fuzzy rule interpolation techniques. Section III describes how to represent fuzzy interpolative reasoning concepts in the framework of ATMS and GDE to generate candidates for modification. Section IV proposes a modification mechanism for the generated candidates. Whilst all the key concepts are illustrated by a running example throughout Sections III and IV, a realistic application is given

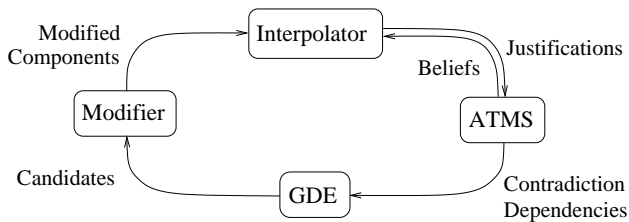

Fig. 1. Adaptive interpolative reasoning process

in Section V, showing the potential of using this approach for the prediction of diarrheal diseases in remote villages. Section VI concludes the paper, with possible further work suggested.

II. TRANSFORMATION-BASED INTERPOLATION

Since the inception of the *compositional rule of inference (CRI)* [68], many fuzzy inference methods have been proposed in the literature. However, the great majority of such methods are only applicable to problems where a dense rule base is available. Fuzzy interpolative reasoning has been introduced to address this limitation [42], [43]. In order to make the interpolated result interpretable, convexity is required [47]. Unfortunately, this is not always the case for the original method [65]. To eliminate this deficiency, various interpolation methods have been developed. Amongst these, the initial formulated approach works by introducing the concept of intermediate rules [62]. The approach first interpolates an intermediate rule such that the antecedent of this rule is as “close” (given a fuzzy distance metric) to the observation as possible. Then a conclusion is calculated from the given observation by firing the generated intermediate rule.

A variety of methods to generate an intermediate rule and to infer a conclusion from the given observation by the intermediate rule have been developed in the literature, e.g. [2], [13], [37], [38], [39]. In particular, the scale and move transformation-based approach ([37], [38], [39]) has the following properties:

- It can handle both interpolation and extrapolation which involve multiple fuzzy rules, with each rule consisting of multiple antecedents.
- It guarantees the uniqueness as well as normality and convexity of the resulting interpolated fuzzy sets.
- It preserves piece-wise linearity such that interpolation can be computed using only characteristic points which describe a given polygonal fuzzy set, thereby ignoring any non-characteristic points and saving computation effort.
- It has been applied to problems such as truck backer-upper control and computer activity prediction [38].

Note that although many approaches to fuzzy interpolation have been developed with an aim to improve the interpretability of interpolated results (as indicated above), this paper will focus on the issue of maximising the consistency of interpolated values throughout an interpolative reasoning process. Informally, consistency means that a variable’s value should remain the same whether it is observed or interpolated

at the different stages of the interpolation process. This is different from interpretability which reflects the need for the reasoning results to be readily understandable in terms of their underlying semantics. Note also that the scale and move transformation-based approach will be adopted as the foundation for the proposed research in this paper, although the work is restricted to fuzzy interpolation with 2 rules only, with each rule involving multiple antecedents. For completeness, an outline of the restricted scale and move transformation-based approach is given below together with a brief overview of other relevant approaches.

A. Outline of the scale and move transformation-based approach

For fuzzy rule interpolation, normal and convex fuzzy sets are of particular interest, which are shortened as fuzzy sets in this paper for simplicity. Let x and y be real variables, and A, B, C, \dots be fuzzy sets. Given a fuzzy set A , the α -cut of A is defined as $(A)_\alpha = \{x \in D_x | \mu_A(x) \geq \alpha, \alpha \in [0, 1]\}$, where D_x is the domain of variable x . All variables which are involved in the reasoning process satisfy a partial ordering, denoted by \preceq [43]. For any two fuzzy sets A and A' with respect to the same variable, $A \preceq A'$ if and only if $\inf\{(A)_\alpha\} \leq \inf\{(A')_\alpha\}$ and $\sup\{(A)_\alpha\} \leq \sup\{(A')_\alpha\}$ for all $\alpha \in (0, 1)$, where $\inf\{(A)_\alpha\}$ and $\sup\{(A)_\alpha\}$ are the infimum and supremum of $(A)_\alpha$, and $\inf\{(A')_\alpha\}$ and $\sup\{(A')_\alpha\}$ are the infimum and supremum of $(A')_\alpha$. In particular, $A \prec A'$ if and only if $A \preceq A'$ and the two fuzzy sets are not identical.

For simplicity, single antecedent and single consequent rules are considered first. Given an observation or a previously inferred result (with both hereafter being referred to as an observation)

$$O : x \text{ is } A^*, \quad (1)$$

suppose that rules

$$\begin{aligned} R_i &: \text{If } x \text{ is } A_i, \text{ then } y \text{ is } B_i, \\ R_j &: \text{If } x \text{ is } A_j, \text{ then } y \text{ is } B_j, \end{aligned} \quad (2)$$

are its two neighboring rules in a sparse rule base, then: i) $A_i \prec A_j$ or $A_j \prec A_i$; ii) $A_i \preceq A^* \preceq A_j$ or $A_j \preceq A^* \preceq A_i$; and iii) no individual rule “If x is A_k , then y is B_k ” exists such that $A_i \prec A_k \prec A_j$ or $A_j \prec A_k \prec A_i$. The object value B^* of variable y can be derived through scale and move transformation-based fuzzy interpolation. The interpolation process can be illustrated in Fig. 2.

This process is outlined as follows with key concepts introduced after this overview. Given fuzzy sets A_i, A_j and A^* , it first uses real numbers a_i, a_j and a^* termed as *representative values*, to represent the overall position of A_i, A_j and A^* respectively, within the domain of variable x , mapped by the real function f_1 . Then, the relative placement relation between the observation A^* and the antecedents (A_i and A_j) of the two neighboring rules for interpolation is obtained, which corresponds to λ , termed as *relative placement factor*, and which is calculated by the real function f_2 . From this, an intermediate rule $A^{*'} \Rightarrow B^{*'}$ can be interpolated by applying real function f_3 with parameter λ applied to

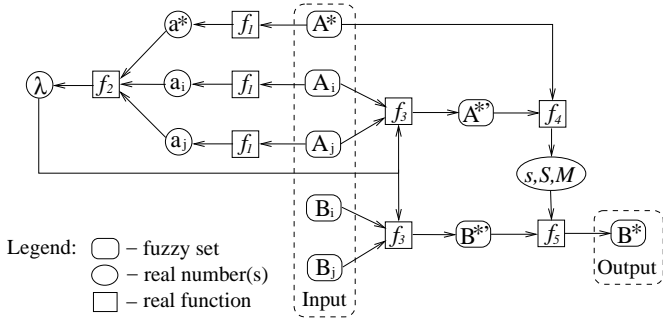

Fig. 2. Transformation-based interpolation

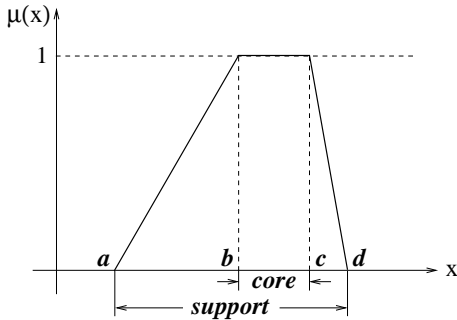

Fig. 3. Trapezoidal fuzzy set

both the antecedents and consequents of the neighboring rules for interpolation. The *representative value* of the resulting antecedent A^* is guaranteed to be equal to that of A^* by real functions f_2 and f_3 , though the two fuzzy sets are usually not identical. Next, the similarity degree between A^* and $A^{*'}$ is calculated by a predefined similarity measure. Specifically, scale rate s , scale ratio \mathbb{S} and move rate \mathbb{M} are used in scale and move transformation-based interpolation to represent the similarity degree, which is achieved by function f_4 . Finally, the consequence of the interpolated rule B^* is computed by applying the transformation function f_5 to $B^{*'}$, while imposing the same similarity degree.

B. Representative value

The *representative value* of a fuzzy set captures its overall location in the underlying definition domain [37]. It provides a useful linkage between conventional numerical interpolation and fuzzy interpolation. When fuzzy sets are replaced by their *representative values*, fuzzy interpolation degenerates to numerical interpolation.

Consider a trapezoidal fuzzy set A , as illustrated in Fig. 3, which can be concisely expressed as a quadruple $A = (a, b, c, d)$ [53]. In particular, $[a, d]$ is termed the *support* of fuzzy set A , i.e. $\text{supp}(A) = \{x \in D_x | \mu_A(x) > 0\}$; $[b, c]$ is termed the *core* of fuzzy set A , i.e. $\text{core}(A) = \{x \in D_x | \mu_A(x) = 1\}$; and $[a, b]$ and $[c, d]$ are termed the *left slope* and *right slope* of fuzzy set A , respectively. The *representative value* of such a fuzzy set is defined by:

$$\text{Rep}(A) = w_0 \frac{a+d}{2} + w_1 \frac{b+c}{2}, \quad (3)$$

where w_0 and w_1 are the weights of the *support* and *core*

of fuzzy set A , respectively. A simple weighting scheme is that the *support* and the *core* are assigned the same value (i.e. $w_0 = w_1 = 1/2$), which leads to the case of [13]:

$$\text{Rep}(A) = \frac{1}{4}(a + b + c + d). \quad (4)$$

This may further degenerate to the case as introduced in [62] when the *representative value* is solely determined by its *core*:

$$\text{Rep}(A) = \frac{1}{2}(b + c). \quad (5)$$

The concept of *representative value* can be generalized straightforwardly to any arbitrary polygonal fuzzy set. Given an arbitrary polygonal fuzzy set A' with $2(n+1)$ characteristic points, which is denoted as a set of level cuts $A' = \{(0, [p_0, q_0]), (\alpha_1, [p_1, q_1]), \dots, (\alpha_n, [p_n, q_n])\}$ such that $\text{supp}(A') = [p_0, q_0]$, $\alpha_1 > 0$, $\alpha_n = 1$, $\alpha_l < \alpha_{l+1}$ ($l \in \{1, 2, \dots, n-1\}$) and $\mu_{A'}(p_k) = \mu_{A'}(q_k) = \alpha_k$ ($k \in \{1, 2, \dots, n\}$), the *representative value* of A' is computed by:

$$\text{Rep}(A') = w_0 \frac{p_0 + q_0}{2} + \sum_{k=1}^n w_k \frac{p_k + q_k}{2}, \quad (6)$$

which is a generalization of Eq. 3. Similarly, Eqs. 4 and 5 can also be generalized in the same manner.

For simplicity, the rest of this paper is developed based on trapezoidal fuzzy sets only due to the following reasons: (a) An arbitrary polygonal fuzzy set can be seen as a collection of nested trapezoids (while triangles are special cases of trapezoids) and thus the concepts about arbitrary polygonal fuzzy sets can be generalized straightforwardly from those about trapezoidal fuzzy sets. (b) The scale and move transformation-based interpolation approach with arbitrary polygonal fuzzy sets is a generalization of that with trapezoidal fuzzy sets.

C. Relative placement factor

The *relative placement factor* λ of the observation A^* , with respect to its corresponding two neighboring rule antecedents A_i and A_j , is defined as the ratio of $d(A_i, A^*)$ to $d(A_i, A_j)$:

$$\lambda = \frac{d(A_i, A^*)}{d(A_i, A_j)}, \quad (7)$$

where $d(A, A')$ is the distance between fuzzy sets A and A' (measured by a certain distance metric). Such a factor reflects the relative location of the interpolated rule regarding the two neighboring rules. Thanks to the concept of *representative value*, the distance between two fuzzy sets A and A' can be defined by:

$$d(A, A') = \text{Rep}(A') - \text{Rep}(A). \quad (8)$$

Note that $\text{Rep}(A_i) \neq \text{Rep}(A_j)$ because $A_i \prec A_j$ or $A_j \prec A_i$.

D. Generation of intermediate rule

From the calculated *relative placement factor* λ , the antecedent $A^{*'} = (a^{*'}, b^{*'}, c^{*'}, d^{*'})$ of the intermediate rule $A^{*'} \Rightarrow B^{*'}$ can be generated. In particular, the characteristic

points of $A^{*'}$ are computed as follows:

$$\begin{aligned} a^{*'} &= (1 - \lambda)a_i + \lambda a_j & b^{*'} &= (1 - \lambda)b_i + \lambda b_j \\ c^{*'} &= (1 - \lambda)c_i + \lambda c_j & d^{*'} &= (1 - \lambda)d_i + \lambda d_j \end{aligned} \quad (9)$$

which are collectively abbreviated to:

$$A^{*'} = (1 - \lambda)A_i + \lambda A_j. \quad (10)$$

In so doing, the *representative value* of the calculated $A^{*'}$ is guaranteed to be equal to that of the given observation A^* (refer to [37] for details). Similarly, the consequence of the intermediate rule is generated using the same *relative placement factor* λ by analogy to the generation of the antecedent:

$$B^{*'} = (1 - \lambda)B_i + \lambda B_j. \quad (11)$$

Note that the interpolated intermediate rule is normal and convex.

E. Firing the intermediate rule

Having generated the intermediate rule, the next step is to execute the rule with the given observation, which is achieved by employing a *similarity reasoning* mechanism. Suppose that the interpolated intermediate rule is $A^{*'} \Rightarrow B^{*'}$, and that the observation is A^* . The conclusion B^* is calculated with respect to the following intuition:

The more similar A^* is to $A^{*'}$, the more similar B^* is to $B^{*'}$. (12)

Given two fuzzy sets with the same representative value, the similarity between them is assessed through a process of two transformation steps, namely, *scale transformation* and *move transformation*. In particular, three parameters: *scale rate*, *scale ratio* and *move rate* are introduced to measure the scales of these two transformations. *Scale rate* and *scale ratio* measure the “fuzziness” difference of the two sets by comparing the lengths of a certain level cut, while *move rate* measures the “position” difference by comparing their shifts on the given level cut. From this, the consequence B^* can be obtained by modifying $B^{*'}$ with the same scale and move parameters as used for transforming $A^{*'}$ to A^* . For simplicity, the two transformation steps are jointly represented by an integrated transformation function such that:

$$T(B^{*'}, B^*) = T(A^{*'}, A^*), \quad (13)$$

which ensures that the degree of the similarity between $B^{*'}$ and B^* is the same as that between $A^{*'}$ and A^* . The details of these transformations and the computation of the scale and move rates are omitted here due to limitations of space, but can be found in [37], [38].

F. Multiple-antecedent rule interpolation

Multiple-antecedent rule interpolation is a generalization of single-antecedent rule interpolation. Given an observation

$$O : x_1 \text{ is } A_{1x}^* \text{ and } \dots \text{ and } X_m \text{ is } A_{mx}^*, \quad (14)$$

suppose that rules

$$\begin{aligned} R_i &: \text{ If } x_1 \text{ is } A_{1i} \text{ and } \dots \text{ and } x_m \text{ is } A_{mi}, \text{ then } y \text{ is } B_i, \\ R_j &: \text{ If } x_1 \text{ is } A_{1j} \text{ and } \dots \text{ and } x_m \text{ is } A_{mj}, \text{ then } y \text{ is } B_j, \end{aligned} \quad (15)$$

are used for interpolation with respect to the observation O , which are referred to as that “rules R_i and R_j flank the observation O ”. For simplicity, such two rules will be referred to as the “neighboring rules” hereafter. Similar to the single-antecedent rule situation, the neighboring rules R_i and R_j must satisfy: i) $A_{ki} \prec A_{kj}$ or $A_{kj} \prec A_{ki}$, $\forall k \in \{1, 2, \dots, m\}$; ii) $A_{ki} \preceq A_{kx}^* \preceq A_{kj}$ or $A_{kj} \preceq A_{kx}^* \preceq A_{ki}$, $\forall k \in \{1, 2, \dots, m\}$; and iii) the distance between the antecedents of rules R_i and R_j is the smallest amongst those of all the rule pairs in the rule base satisfying i) and ii) at the same time.

Knowing the distance between each pair of fuzzy sets A_{ki} ($1 \leq k \leq m$) and A_{kj} calculated by Eq. 8, the distance between the antecedents of rules R_i and R_j can be defined as the Euclidean distance within the input space (though other alternative distance metrics may be used). However, the absolute distances within different dimensions may not be compatible because different attributes have different domains. In order to make them compatible, the normalized attribute distance is defined by:

$$d'_k = \frac{d(A_{ki}, A_{kj})}{\max_k - \min_k}, \quad (16)$$

where \max_k and \min_k are the maximal and minimal values in the domain of attribute k , respectively. From this, the normalized distance d' between the antecedents of rules R_i and R_j is calculated by:

$$d' = \frac{1}{m} \sqrt{\sum_{k=1}^m d_k'^2}. \quad (17)$$

Then, the distance d between the antecedents of rules R_i and R_j is defined as the denormalisation of d' :

$$d = d' \sqrt{\sum_{k=1}^m (\max_k - \min_k)^2}. \quad (18)$$

Note that if the neighboring rules of Eq. 15 degenerate to those of a single antecedent of Eq. 2, Eq. 18 degenerates to Eq. 8.

Having known the neighboring rules for interpolation, the process of deriving the object value B^* of the consequent variable y is illustrated in Fig. 4. In this figure, there are m repeated components which are identical to the core of the single-antecedent rule interpolation (Fig. 2). Each of these components does exactly the same as the common core of the single-antecedent situation. That is, relative placement factor λ_k ($1 \leq k \leq m$) and similarity rates (s_k , \mathbb{S}_k , \mathbb{M}_k) are calculated from each term of the observation A_{kx}^* and the corresponding two fuzzy sets A_{ki} and A_{kj} . Function f_6 is introduced to combine all these λ_k ($k \in \{1, 2, \dots, m\}$) to a single scale λ , as is f_7 to combine all the similarity rates (s_k , \mathbb{S}_k , \mathbb{M}_k) to $(s, \mathbb{S}, \mathbb{M})$. Various combination functions may be chosen for f_6 and f_7 [5], [6]. For instance, the chosen function could be weighted average operator or medium value operator.

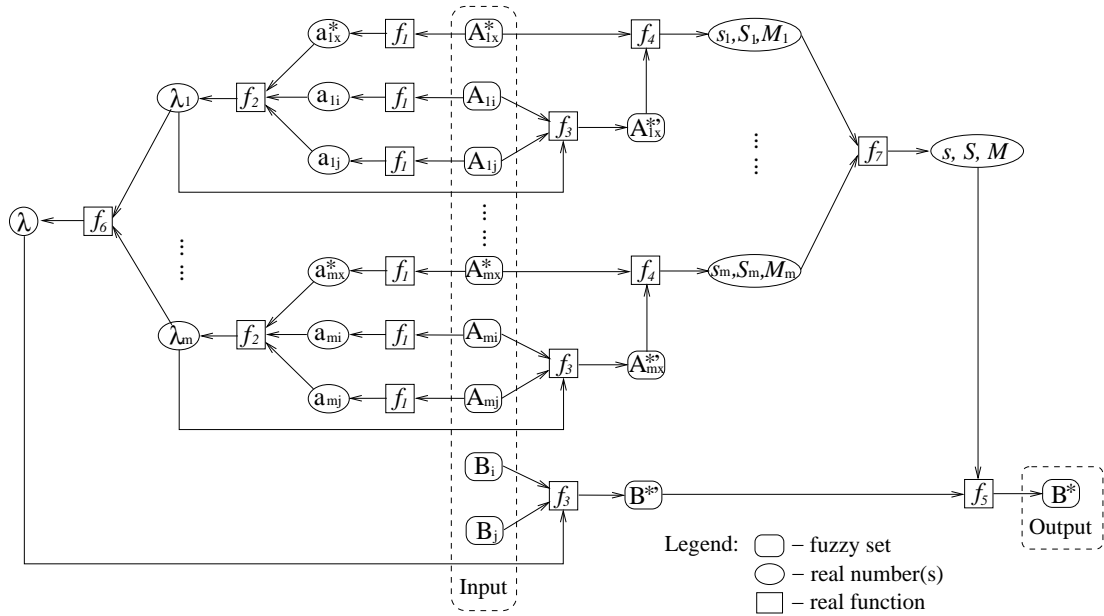

Fig. 4. Transformation-based interpolation for multiple-antecedent rules

The simplest case is the arithmetic average operator:

$$r = \frac{1}{m} \sum_{k=1}^m r_k, \quad (19)$$

where r stands for similarity rates s , S and M or relative placement factors λ . This operator will be used in the running example below.

The combined similarity rate reflects the similarity degree between the observation and the antecedents of the intermediate rule. The conclusion B^* can then be estimated by transforming the consequent $B^{*'}$ of the intermediate rule via the application of the combined similarity rate, using transformation function f_5 :

$$T(B^{*'}, B^*) = T((A_{1x}^{*'}, \dots, A_{mx}^{*'}), (A_{1x}, \dots, A_{mx})). \quad (20)$$

G. Other implementations

The discussions throughout this paper focus on the scale and move transformation-based approach (due to its basic properties stated previously). However, the work is developed with an aim to suit a variety of intermediate rule-based interpolation approaches, including the following important implementations. The technique of [62] employs the same method for generating intermediate rules as outlined above, but the *representative value* is restricted to the middle point of *core* (i.e. Eq. 5). The similarity degree is captured using the so-called *lower similarity* and *upper similarity*. By reference to the middle point of the *core*, a normal and convex fuzzy set can be divided into two parts, namely the lower part and the upper part. The *lower similarity* measures the difference of the lower parts of two fuzzy sets by comparing the lengths of a certain level cut, and *upper similarity* does that of the upper parts.

The approach of [13] ensures that the *core* of each fuzzy set of a created intermediate rule is equal to that of the

corresponding fuzzy set of the resulting interpolated rule. In order to measure the similarity degree between two fuzzy sets with the same *core*, only their *left slopes* and *right slopes* need to be compared. Two transformations, that is, *increment transformation* and *ratio transformation* are utilized for this purpose, with one aiming to increase the length of a certain level cut of a *slope* during the transformation, and the other to decrease the length. A group of intermediate rule generation and firing algorithms have also been reported in [2] by means of fuzzy relations and semantic relations. For details of these implementations, refer to the corresponding references given above.

III. MINIMAL CANDIDATE GENERATION

In fuzzy reasoning, including fuzzy interpolation, it is possible that more than one object value of a single variable is derived. This implies that certain inconsistencies have been reached. For example, variable x is used to illustrate a person's height. It is possible that x is tall is held in one situation and that x is short in another, while it is contradictory for x is tall and x is short to be held simultaneously in one single situation, knowing that *tall* and *short* represent two semantically different object values. Given such an inconsistency, for fuzzy interpolation, unless it is caused by contradictory observations, the method employed is the only cause of contradiction (if the neighboring rules used are presumed to be true).

In this work, each pair of neighboring rules is seen as a fuzzy reasoning component which takes a certain number of fuzzy sets as input and produces another fuzzy set as output, as illustrated in Fig. 5. The input is an observation or a previously inferred result, which is of the form (1) or (14). Rules i and j flank the given observation and are of the form (2) for single-premise, or form (15) for multiple-premise. The result is inferred from the input observation by such two neighboring rules as explained earlier. Accordingly, a contradiction in

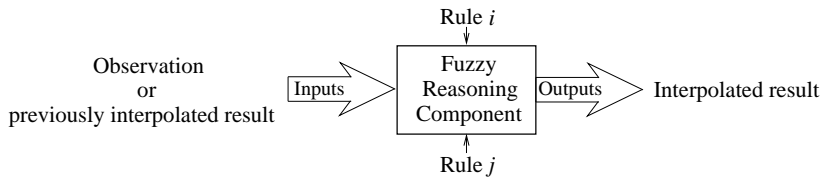

Fig. 5. Fuzzy reasoning component

this context means that at least one of the fuzzy reasoning components that it depends on is defective unless the original given observations are themselves inconsistent.

To efficiently record the dependencies between a derived proposition and its preceding fuzzy interpolative reasoning components, including those which lead to contradictions, ATMS is used here. GDE, which is built on the basis of ATMS, can then be employed to generate minimal faulty reasoning component candidates, with each of which explaining the entire set of current contradictions. A minimal candidate is a possible minimal set of defective components which need to be corrected at one time in order to remove all the contradictions.

A. Contradictions in interpolation

In classical reasoning, at a given time, if two unequal values are derived (or one derived and another observed) for one single variable, there is a contradiction. The situation is different in fuzzy reasoning, as “unequal” in fuzzy representation is a matter of degree. For fuzzy systems, the concept of contradiction is replaced by the concept of dissimilarity between the derived logical consequences for any given variable. The degree of matching is frequently used for expressing the extent of similarity between two fuzzy sets. Numerous methods have been proposed to calculate fuzzy matching degrees in the literature [15], [69], which can be typically categorized into two classes: *geometric distance-based measures* and *set theory-based measures*. The former are the extensions of the classical concept of metric space and the associated distance function, while the latter are built on the basis of set operators, such as *t*-norms and *t*-conorms.

1) *Geometric distance-based matching degree*: This extends the Euclidean distance between two points to a fuzzy distance between two fuzzy sets, to express the extent to which the fuzzy sets match. An extensive mathematical literature exists for computing such measures (e.g. [10], [11], [22], [25], [34], [49], [51]). Having defined the *representative value* of a fuzzy set, the matching degree between two fuzzy sets can be easily calculated. This is because the distance between two fuzzy sets degenerates to the geometric distance between their *representative values*. Thus, the matching degree between two fuzzy sets A_i and A_j , denoted as $M(A_i, A_j)$, in the domain D_x of variable x can be defined by:

$$M(A_i, A_j) = \begin{cases} 1, & \\ \text{if } d(A_i, A_j) = S_i = S_j = 0 & \\ 1 - \frac{d(A_i, A_j)}{d(A_i, A_j) + \frac{S_i + S_j}{2}}, & \\ \text{otherwise} & \end{cases} \quad (21)$$

where S_k is the area of fuzzy set A_k . Given a trapezoidal fuzzy set $A_k = (a, b, c, d)$, S_k can be calculated by:

$$S_k = \frac{1}{2}[(d - a) + (c - b)]. \quad (22)$$

The benefits of using this *representative value*-based matching measure are: i) a unitary *representative value* of each fuzzy set is used for both the fuzzy rule interpolation phase and the contradiction calculation phase; and ii) the *representative value* for each fuzzy set only needs to be calculated once, saving computational effort.

2) *Set theory-based matching degree*: An alternative way to measure the similarity degree between two fuzzy sets is developed from the set theory. This approach is rooted in the assertion that the assessment of similarity may be better described as a comparison of features rather than as a computation of metric distance between points [58]. For instance, in case-based reasoning, the determination of the most relevant (or optimal) case that is to be retrieved is based on the similarity degrees which are usually computed by comparison of the involved features [52]. In the area of pattern recognition, the similarity between an object and a pattern class can be identified also by comparison of features [4]. Similarity among objects is expressed as a linear combination of the measures of their common and distinct features, which degenerates to set operations when special parameters are chosen. A number of fuzzy distance measures have been proposed in the literature as the extensions or generalizations of this concept [14], [27], [28]. Particularly, the matching degree between two fuzzy sets A_i and A_j , denoted as $M(A_i, A_j)$, in the domain D_x of variable x can be defined as:

$$M(A_i, A_j) = \sup_{x \in D_x} [\min(\mu_{A_i}(x), \mu_{A_j}(x))]. \quad (23)$$

This is in accordance with the implication-based interpretation of fuzzy rules, as opposed to the conjunction-based interpretation [29], [30].

Both similarity measures proposed above follow the properties of *symmetry* and *reflexivity* which are necessary for any matching degree metric. Thus, a choice may be made according to the given application problem. In particular, the *representative value*-based similarity measure is sensitive among different pairs of disjoint fuzzy sets, while the *set theory-based* is sensitive among different pairs of joint fuzzy sets.

3) *Specification of contradiction*: Based on the concept of matching degree, the degree β of a contradiction with respect to two propositions $P(x \text{ is } A_i)$ and $P'(x \text{ is } A_j)$ is specified by:

$$\beta = 1 - M(A_i, A_j). \quad (24)$$

A predefined threshold β_0 ($0 \leq \beta_0 \leq 1$) can be adopted in order to determine those values assigned to a common variable with an unacceptable contradictory degree. A contradiction is called a β_0 -contradiction if the corresponding degree of contradiction $\beta > \beta_0$.

In fuzzy interpolation, when two or more values of a common variable are obtained, the degree of contradiction between each pair of values is calculated as above. From this, the following interpretations will be adopted in this paper: (i) $\beta = 0$, that is $M(A_i, A_j) = 1$, which means that the two propositions P and P' are not contradictory at all; in other words, they are totally consistent; (ii) $0 < \beta \leq \beta_0$, that is $1 - \beta_0 \leq M(A_i, A_j) < 1$, which means that the two propositions P and P' are slightly contradictory and the degree of contradiction is tolerable in the computation; (iii) $\beta_0 < \beta < 1$, that is $0 < M(A_i, A_j) < 1 - \beta_0$, which means that the two propositions P and P' are seriously contradictory and the degree of contradiction is intolerable; (iv) $\beta = 1$, that is $M(A_i, A_j) = 0$, which means that the two propositions P and P' are totally contradictory, and not consistent at all.

B. Representation of interpolation concepts in ATMS

In this work, ATMS is used to record the dependency of the interpolated results as well as the contradictions derived from those fuzzy reasoning components. That is, propositions, contradictions and fuzzy interpolative reasoning components are all represented as ATMS nodes. In addition to the so-called datum field [18], which trivially denotes a proposition (including the term “false” to represent inconsistency) or a fuzzy reasoning component, an ATMS node has two other fields: justification and label.

1) *Justification*: A justification describes how a node is derivable from other nodes. Each fuzzy reasoning component is assumed to be initially true and may be detected to be false later. For such a node (i.e. an assumption in classical ATMS terms [18]), its justification just assumes itself to be true. For any given observation O (i.e. a premise [18]), its corresponding ATMS node has a justification with no antecedent because it is supposed to hold universally, which can be represented as:

$$\Rightarrow O. \quad (25)$$

Any ATMS node with an inferred proposition (i.e. a derived node [18]), which is obtained through fuzzy interpolative reasoning, can be represented by an ATMS justification as:

$$O, R_i R_j \Rightarrow C, \quad (26)$$

where $R_i R_j$ stands for the fuzzy reasoning component with respect to the two neighboring rules R_i and R_j ($i \neq j$) that have been used to infer the outcome C from the observation O . More generally, a node N that is inferred by n other nodes M_1, M_2, \dots, M_n (each of which may be itself a derived node or an observation) by interpolation through two neighboring rules R_u and R_v ($u \neq v$) is denoted by:

$$M_1, M_2, \dots, M_n, R_u R_v \Rightarrow N. \quad (27)$$

In addition, as discussed previously, any two propositions P (x is A_i) and P' (x is A_j) are considered contradictory

if A_i and A_j are not identical. Due to fuzzy matching, such contradictions are to a certain degree β . When β is not higher than a given threshold β_0 , the contradictory degree is deemed acceptable and the two considered propositions are treated as being consistent in ATMS. Otherwise, a β_0 -contradiction is deduced, which is represented as:

$$P, P' \Rightarrow_{\beta_0} \perp. \quad (28)$$

2) *Label and label-updating*: A label is a set of environments each supporting the associated node. An environment contains a minimal set of fuzzy reasoning components that jointly entail the node from an observation, thereby describing how the node depends on those fuzzy reasoning components. An environment is said to be β_0 -inconsistent if β_0 -contradiction is derivable propositionally from the environment and a given justification. An environment is said to be $(1 - \beta_0)$ -consistent if it is not β_0 -inconsistent.

The label of each node is guaranteed to be $(1 - \beta_0)$ -consistent, sound, minimal and complete, except that the label of the special “false” node is β_0 -inconsistent rather than $(1 - \beta_0)$ -consistent. The interpretation of these properties is summarized as follows:

- $(1 - \beta_0)$ -consistency means that all environments in the label are at least $(1 - \beta_0)$ -consistent;
- $(1 - \beta_0)$ -soundness indicates that the node is derivable from each environment in the label at least to the consistent degree of $(1 - \beta_0)$;
- $(1 - \beta_0)$ -minimality states that the removal of any element from any environment will cause the node to be undervivable from that environment and hence violating the label’s $(1 - \beta_0)$ -soundness;
- $(1 - \beta_0)$ -completeness implies that every $(1 - \beta_0)$ -consistent environment, from which the node is derivable, is a superset of a certain environment in the label. In other words, all minimal $(1 - \beta_0)$ -consistent environments of the subject node are held within the label.

The label-updating algorithm of the ATMS ensures that the above four properties are held. The extended algorithm for label-updating in this work is exactly the same as the original given in [18], except that the environments of a proposition are now at least $(1 - \beta_0)$ -consistent rather than 1-consistent and that the environments of a contradiction are at least β_0 -inconsistent rather than 1-inconsistent (i.e. a contradiction is at least β_0 -contradictory rather than 1-contradictory). In particular, the label of the special “false” node gathers all β_0 -inconsistent environments. Whenever a β_0 -contradiction is detected, each environment in its label is added into the label of the specific “false” node and all such environments and their supersets are removed from the label of every other node. Also, any such an environment which is a superset of another is removed from the label of the node “false”.

Accordingly, the concept of an ATMS context with respect to a $(1 - \beta_0)$ -consistent environment, is herein defined by the collection of both the assumptions contained within this environment and all those nodes that can be derived from these assumptions. Of course, these derived nodes can not be

β_0 -inconsistent because they are deduced from a $(1 - \beta_0)$ -consistent environment. Note that there are a number of fuzzy extensions of de Kleer's ATMS in the literature, such as [7], [8], [26], [55]. All these extensions introduce truth values into ATMS. They may be of great significance when this work is extended to deal with truth values of propositions or rules, but are beyond the scope of this paper.

Example 3.1: Suppose that the sparse rule base for a practical problem is given as follows:

- R_1 : If x_1 is A_1 , then x_2 is B_1 ;
- R_2 : If x_1 is A_2 , then x_2 is B_2 ;
- R_3 : If x_2 is B_3 , then x_3 is C_3 ;
- R_4 : If x_2 is B_4 , then x_3 is C_4 ;
- R_5 : If x_3 is C_5 , then x_6 is F_5 ;
- R_6 : If x_3 is C_6 , then x_6 is F_6 ;
- R_7 : If x_3 is C_7 and x_4 is D_7 , then x_5 is E_7 ;
- R_8 : If x_3 is C_8 and x_4 is D_8 , then x_5 is E_8 ;
- R_9 : If x_6 is F_9 , then x_7 is G_9 ;
- R_{10} : If x_6 is F_{10} , then x_7 is G_{10} ;
- R_{11} : If x_5 is E_{11} , then x_7 is G_{11} ;
- R_{12} : If x_5 is E_{12} , then x_7 is G_{12} .

In this example, trapezoids are used to represent fuzzy sets with *representative values* calculated by Eq. 4. For simplicity, the set-theory based similarity measure given by Eq. 23 is used to calculate the contradictory degree. Given $\beta_0 = 0.5$ and four observations, $x_1 = A^* = (9.0, 9.5, 10.0, 10.5)$, $x_2 = B^* = (7.0, 7.5, 8.0, 8.5)$, $x_4 = D^* = (5.5, 6.0, 6.5, 7.0)$ and $x_6 = F^* = (11.0, 11.5, 12.0, 12.5)$, the interpolation procedures are illustrated in Fig. 6.

In this figure, an arrowed line flanked by two rules R_i and R_{i+1} , $i \in \{1, 3, 5, 7, 9, 11\}$, represents a fuzzy reasoning component, which is denoted as $R_i R_{i+1}$, where R_i and R_{i+1} are the neighboring rules used for interpolation. ATMS nodes and contradictions are represented by circles. Particularly, each of F_j , $j \in \{1, 2, \dots, 6\}$, is a node denoting a fuzzy reasoning component; each of P_k , $k \in \{1, 2, \dots, 15\}$, is a node denoting a proposition; and each of \perp_l , $l \in \{1, 2, \dots, 8\}$, denotes a β_0 -contradiction. For instance, node P_8 is inferred from nodes P_4 and P_6 by fuzzy reasoning component F_4 , whose justification is therefore $P_4, P_6, F_4 \Rightarrow P_8$, where P_4 is an observation and P_6 is a previously interpolated result. The label of node P_8 ($\{\{R_3 R_4, R_7 R_8\}\}$) is derived from the labels of fuzzy reasoning component F_4 ($\{\{R_7 R_8\}\}$), node P_4 ($\{\{\}\}$) and node P_6 ($\{\{R_3 R_4\}\}$) by the ATMS label-updating algorithm. All these ATMS nodes and contradictions are listed as follows, with all justifications omitted:

- $F_1 : \langle R_1 R_2, \{\{R_1 R_2\}\} \rangle$;
- $F_2 : \langle R_3 R_4, \{\{R_3 R_4\}\} \rangle$;
- $F_3 : \langle R_5 R_6, \{\{R_5 R_6\}\} \rangle$;
- $F_4 : \langle R_7 R_8, \{\{R_7 R_8\}\} \rangle$;
- $F_5 : \langle R_9 R_{10}, \{\{R_9 R_{10}\}\} \rangle$;
- $F_6 : \langle R_{11} R_{12}, \{\{R_{11} R_{12}\}\} \rangle$;
- $P_1 : \langle x_1 = A^*, \{\{\}\} \rangle$;
- $P_2 : \langle x_2 = B_1^*, \{\{R_1 R_2\}\} \rangle$;
- $P_3 : \langle x_3 = C_1^*, \{\{R_1 R_2, R_3 R_4\}\} \rangle$;
- $P_4 : \langle x_4 = D^*, \{\{\}\} \rangle$;
- $P_5 : \langle x_2 = B^*, \{\{\}\} \rangle$;
- $P_6 : \langle x_3 = C_2^*, \{\{R_3 R_4\}\} \rangle$;
- $P_7 : \langle x_5 = E_1^*, \{\{R_1 R_2, R_3 R_4, R_7 R_8\}\} \rangle$;
- $P_8 : \langle x_5 = E_2^*, \{\{R_3 R_4, R_7 R_8\}\} \rangle$;
- $P_9 : \langle x_6 = F_2^*, \{\{R_3 R_4, R_5 R_6\}\} \rangle$;
- $P_{10} : \langle x_6 = F_1^*, \{\{R_1 R_2, R_3 R_4, R_5 R_6\}\} \rangle$;

- $P_{11} : \langle x_6 = F^*, \{\{\}\} \rangle$;
- $P_{12} : \langle x_7 = G_2^*, \{\{R_3 R_4, R_5 R_6, R_9 R_{10}\}\} \rangle$;
- $P_{13} : \langle x_7 = G_1^*, \{\{R_1 R_2, R_3 R_4, R_5 R_6, R_9 R_{10}\}\} \rangle$;
- $P_{14} : \langle x_7 = G_3^*, \{\{R_3 R_4, R_7 R_8, R_{11} R_{12}\}, \{R_9 R_{10}\}\} \rangle$;
- $P_{15} : \langle x_7 = G_4^*, \{\{R_1 R_2, R_3 R_4, R_7 R_8, R_{11} R_{12}\}\} \rangle$;
- $\perp_1 : \langle \perp, \{\{R_1 R_2, R_3 R_4, R_7 R_8\}\} \rangle$;
- $\perp_2 : \langle \perp, \{\{R_3 R_4, R_5 R_6\}\} \rangle$;
- $\perp_3 : \langle \perp, \{\{R_1 R_2, R_3 R_4, R_5 R_6\}\} \rangle$;
- $\perp_4 : \langle \perp, \{\{R_3 R_4, R_5 R_6, R_9 R_{10}\}\} \rangle$;
- $\perp_5 : \langle \perp, \{\{R_1 R_2, R_3 R_4, R_5 R_6, R_9 R_{10}\}\} \rangle$;
- $\perp_6 : \langle \perp, \{\{R_1 R_2, R_3 R_4, R_7 R_8, R_{11} R_{12}\}\} \rangle$;
- $\perp_7 : \langle \perp, \{\{R_1 R_2, R_3 R_4, R_5 R_6, R_7 R_8, R_9 R_{10}, R_{11} R_{12}\}\} \rangle$;
- $\perp_8 : \langle \perp, \{\{R_1 R_2, R_3 R_4, R_5 R_6, R_7 R_8, R_9 R_{10}, R_{11} R_{12}\}\} \rangle$.

By the label-updating algorithm, a specific ATMS node “false”, denoted by P_{\perp} , which collectively represents all the contradictions listed above from \perp_1 to \perp_8 , is given as follows: $P_{\perp} : \langle \perp, \{\{R_1 R_2, R_3 R_4, R_7 R_8\}, \{R_3 R_4, R_5 R_6\}\} \rangle$. There are just two minimal environments in the label of the “false” node. This is because all the others are the supersets of at least one of these, which are therefore removed. The label of P_{\perp} means that at least one element of set $\{R_1 R_2, R_3 R_4, R_7 R_8\}$ and one element of set $\{R_3 R_4, R_5 R_6\}$ are faulty simultaneously. Also, the labels of nodes P_i , $i \in \{7, 9, 10, 12, 13, 15\}$, become empty after the removal of those environments which are supersets of at least one environment of the “false” node.

Fig. 7 summarizes the results obtained through the above-described process, including the observations and the interpolated results.

C. Minimal candidate generation by GDE

GDE [21] generates minimal candidates by manipulating the label of the specific “false” node. A candidate is a particular set of assumptions which may be responsible for the entire set of current contradictions. Because a β_0 -inconsistent environment indicates that at least one of its assumptions is faulty, a candidate must have a nonempty intersection with each β_0 -inconsistent environment. Thus, each candidate is constructed by taking one assumption from each environment in the label of the “false” node. Supersets removal then ensures such generated candidates to be minimal. In light of this, a successful correction of any single candidate will remove all the contradictions (see later).

Example 3.2: Consider Example 3.1 further. Traditionally, GDE is used to solve physical world problems which are usually represented by component-based diagrams, by analogue to which the previous reasoning procedures can also be represented (Fig. 8). From this point, GDE can be readily applied in order to identify and isolate those components which have led to faulty interpolated results. According to the “false” node of the ATMS and its label $\{\{R_1 R_2, R_3 R_4, R_7 R_8\}, \{R_3 R_4, R_5 R_6\}\}$, it is obvious that three minimal candidates can be generated:

$$C_1 = [R_3 R_4] \quad C_2 = [R_1 R_2, R_5 R_6] \quad C_3 = [R_5 R_6, R_7 R_8]$$

which means that fuzzy reasoning component $R_3 R_4$ may be defective or that fuzzy reasoning components $R_1 R_2$ and

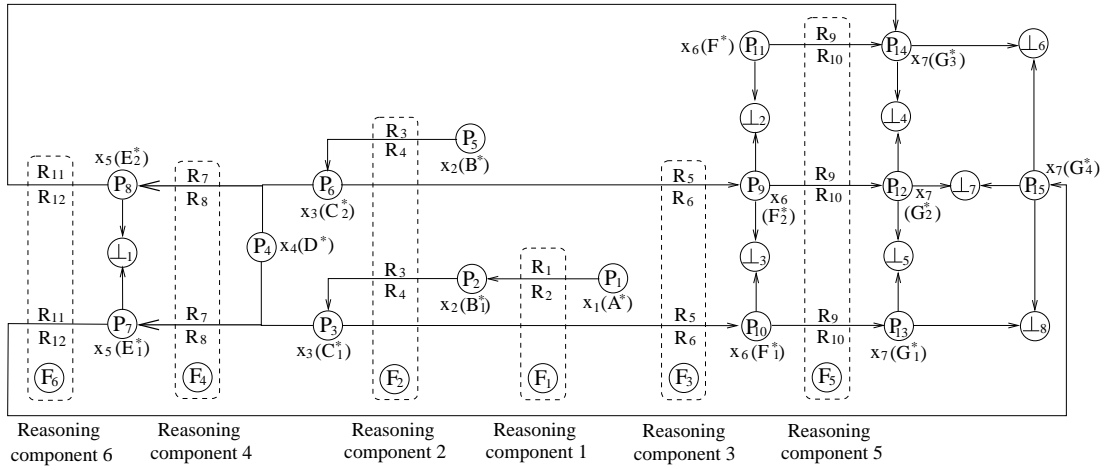

Fig. 6. Discrepancy records in ATMS

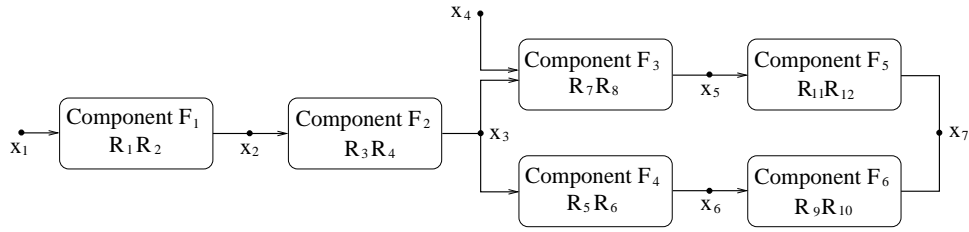

Fig. 8. Component-based representation of the running example

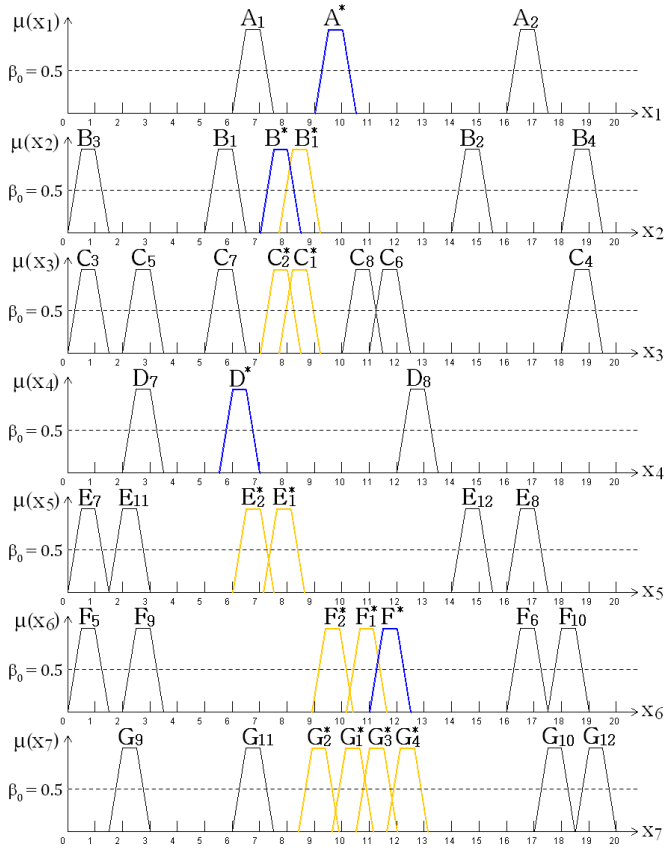

Fig. 7. Fuzzy sets involved in the example

R_5R_6 or R_5R_6 and R_7R_8 may both be defective at the same time. This result can be better understood by examining the following:

- By \perp_1 , at least one element of $\{R_1R_2, R_3R_4, R_7R_8\}$ is faulty;
- By \perp_2 , at least one element of $\{R_3R_4, R_5R_6\}$ is faulty;
- By \perp_3 , at least one element of $\{R_1R_2, R_3R_4, R_5R_6\}$ is faulty;
- By \perp_4 , at least one element of $\{R_3R_4, R_5R_6, R_9R_{10}\}$ is faulty;
- By \perp_5 , at least one element of $\{R_1R_2, R_3R_4, R_5R_6, R_9R_{10}\}$ is faulty;
- By \perp_6 , at least one element of $\{R_1R_2, R_3R_4, R_7R_8, R_{11}R_{12}\}$ is faulty;
- By \perp_7 or \perp_8 , at least one element of $\{R_1R_2, R_3R_4, R_5R_6, R_7R_8, R_9R_{10}, R_{11}R_{12}\}$ is faulty.

What GDE deduces is that at least one of the following three sets of fuzzy reasoning components is faulty, $\{R_3R_4\}$ or $\{R_1R_2, R_5R_6\}$ or $\{R_5R_6, R_7R_8\}$. The set $\{R_3R_4\}$ is considered as a candidate because R_3R_4 belongs to every contradiction given above and if it is faulty, all these seven assertions are explained. Similarly, the set $\{R_1R_2, R_5R_6\}$ is considered as a candidate because if R_1R_2 and R_5R_6 are faulty simultaneously, they jointly explain all these assertions due to at least one element of $\{R_1R_2, R_5R_6\}$ belonging to each conflict listed above. The set $\{R_5R_6, R_7R_8\}$ is also considered as a candidate for the same reason. Any other candidate is a superset of at least one of these three candidates and thus removed.

In terms of interpolation, that fuzzy reasoning component

R_3R_4 is defective means that any interpolated rule whose antecedent is flanked by the antecedents of R_3 and R_4 is faulty and needs to be modified. That fuzzy reasoning components R_1R_2 and R_5R_6 are defective at the same time means that those interpolated rules whose antecedents are flanked by the antecedents of R_1 and R_2 , and by those of R_5 and R_6 , are faulty and need to be modified simultaneously. A similar implication exists given that fuzzy reasoning components R_5R_6 and R_7R_8 are defective. This leads to the development of the following procedure for modification of the identified faulty fuzzy reasoning components.

IV. CANDIDATE MODIFICATION

Having described the method for minimal candidate generation, this section deals with how to correct such defective fuzzy reasoning components. It exploits the presumption that any observed inconsistencies are dependent upon the found faults.

A. Consistency restoring algorithm

Since each single candidate explains the entire set of current contradictions, consistency can be restored by successfully correcting any single candidate. A candidate of the smallest cardinality is the easiest to be modified. Therefore, the smallest candidate in cardinality is always the one to be modified first. However, there are still situations in which more than one candidate have the same size. In this case, the algorithm breaks the tie at random. An alternative way to prioritize the candidates is through the use of the degree of contradiction. Obviously, the higher the threshold taken to detect the contradictory degree, the less sensitive the candidate generation procedure and thus, the fewer candidates that may be generated. Also, the higher the degree of contradiction caused by a candidate, the more likely the candidate to be the actual culprit.

Given a set of ranked candidates, the consistency restoring algorithm tries to correct the candidates one by one until a candidate succeeds (or all fail). For the current working candidate, the algorithm tries to correct each of its defective fuzzy reasoning components and propagate the modification to all the interpolated rules which depend on this defective component by the method to be given in the next section. If the modification is successful, that is all the contradictions have been removed through the correction of all interpolated rules involved in the candidate, the algorithm terminates; otherwise, the algorithm tries the next highest ranked candidate. The flowchart of the algorithm is shown in Fig. 9 and the algorithm itself is outlined in Fig. 10, where $\text{MODIFY}(f)$ is the modification procedure for a single fuzzy reasoning component (f).

As indicated above, the algorithm terminates under two situations. When the termination is caused by an empty candidate set, it means that the modification fails and the proposed modification method is not suitable for the given problem. This implies that the detected inconsistency may have been caused by incorrect observations or incorrect rules originally given, which have mistakenly been presumed to be true. Further modifications in this case remain for future

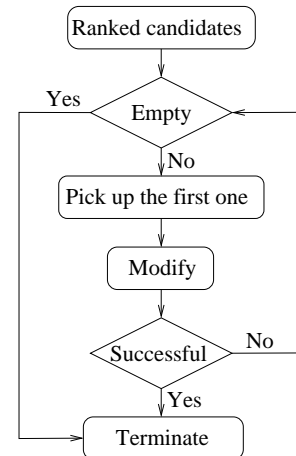

Fig. 9. The flowchart of consistency restoring algorithm

CONSISTENCYRESTORING(\mathbb{Q})

Input:

\mathbb{Q} , a sequence of candidates, each element (C) of which is a set of fuzzy reasoning components (f).

Output:

True, if the modification succeeds;

False, otherwise.

- (1) $success \leftarrow \mathbf{False}$
- (2) **do**
- (3) $C \leftarrow \text{Dequeue}(\mathbb{Q})$
- (4) **foreach** $f \in C$
- (5) $success \leftarrow \text{MODIFY}(f)$
- (6) **if** ($success == \mathbf{False}$)
- (7) **break**
- (8) **until** (($success == \mathbf{True}$) or ($\mathbb{Q} == \emptyset$))
- (9) **return** $success$

Fig. 10. The CONSISTENCYRESTORING procedure

research. However, when the termination is due to a successful modification, it means that consistency has been successfully restored and there is no need to try any other candidate.

Example 4.1: For the running example, there are three candidates in the candidate set. For simplicity, the size-based ranking method is used in this example (with the set theory-based similarity measure used to calculate the contradictory degrees). Because candidate C_1 is smaller than C_2 and C_3 in cardinality, C_1 is chosen to be modified first. Two rules have been interpolated using this fuzzy reasoning component, both of which therefore need to be modified:

IR_1 : If x_2 is B_1^* , then x_3 is C_1^* ;

IR_2 : If x_2 is B^* , then x_3 is C_2^* .

B. Single-premise-based defective reasoning component correction

Inconsistencies result from the failure of interpolation (unless observations and/or original rules have been incorrectly given, which are beyond the scope of this paper). The reason for such a failure is that the same *relative placement factor* is used in both the antecedent and the consequent part

of an interpolated rule. That is, the interpolation presumes that the relationship between the antecedent variable and the consequent variable is linear. An intuitive way to address this issue is to shift the *representative value* of the consequence of a culprit reasoning rule within the interval constructed by the representative values of the two consequences of the neighboring rules that were used for interpolation. This helps to explain all other propositions in the context. In so doing, the consequent value of the computed intermediate rule is changed with respect to the change of the *representative value* of the consequence of the culprit interpolated rule. However, both move and scale rates that are generated by measuring the transformation from the antecedent of the intermediate rule to the antecedent of the interpolated rule remain intact. They are used to transform the consequence of the intermediate rule to the consequence of the modified interpolated rule. This ensures that the similarity between the consequence of the intermediate rule and the consequence of the modified interpolated rule keeps the same as that between the antecedent of the intermediate rule and the antecedent of the interpolated rule.

Based on these considerations, a set of simultaneous equations can be set up regarding all the interpolated rules which are dependent on the same defective fuzzy reasoning component, in order to modify their consequent values. The modification is carried out such that their corresponding propositions are $(1 - \beta_0)$ -consistent with the current context. The solution of these simultaneous equations forms the result of the modification. For convenience, let \widehat{B}^* denote the modified consequence of a culprit interpolated rule $A^* \Rightarrow B^*$, and $\widehat{B}^{*'}$ and $\lambda_{\widehat{B}^*}$ denote the corresponding modified intermediate rule consequence and the *relative placement factor* of \widehat{B}^* , respectively. The following sub-sections describe the requirements that the modification should satisfy and their reasons.

1) *Unique correction rate for rules interpolated from the same defective reasoning component*: There may be more than one interpolated rule dependent on the same defective fuzzy reasoning component. If an interpolated rule is altered because it depends on a defective fuzzy reasoning component, the same must also be applied to all other interpolated rules which depend on the same fuzzy reasoning component.

In this research, all those rules initially provided in the sparse rule base for interpolation are assumed to be fixed and true, and are referred to as base rules. Naturally, the more similar any two rules are to each other, the closer the values of the attributes involved in these rules. Therefore, the interpolated rule whose antecedent is located farthest from both antecedents of a pair of base neighboring rules is the one that is most dissimilar to these neighboring rules. Thus, this farthest rule should be chosen for initial modification. In other words, the rule antecedent which sits nearest the middle of the neighborhood of the two base rules is the one most likely to be wrong and needs to be modified the most. Any other interpolated rules dependent on the same fuzzy reasoning component can then be modified with reference to the modification of this one.

Suppose that the neighboring rules $A_1 \Rightarrow B_1$ and $A_n \Rightarrow B_n$ are the two base rules used by a defective fuzzy reasoning

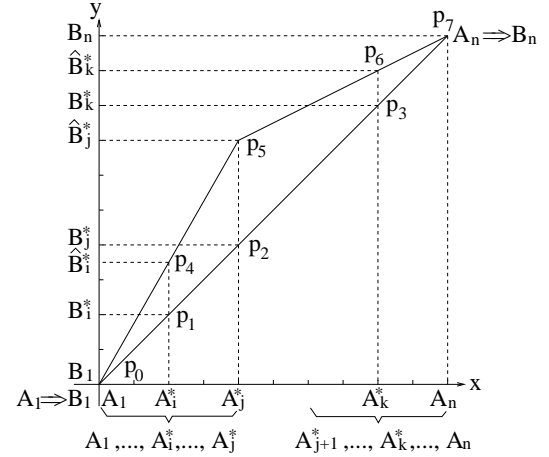

Fig. 11. Single-premise-based defective reasoning component modification

component, that $A_2^*, A_3^*, \dots, A_{n-1}^*$ are observations located between A_1 and A_n , and that A_j^* ($2 \leq j \leq n-1$) is the middle-most one. It is interesting to observe that in computing the transformation-based interpolation, the relation between an antecedent variable and the corresponding consequent variable can be represented by a linear line in a coordinate plane (line P_0P_7 in Fig. 11). The modification breaks this straight line segment P_0P_7 into two connected straight line segments P_0P_5 and P_5P_7 as illustrated in Fig. 11. That is, it uses a first-order piecewise linear approximation to replace the original linear method.

The effect of this proposed modification is to refine the defective fuzzy reasoning component by dividing it into two more accurate fuzzy reasoning components. In Fig. 11, this corresponds to replacing the fuzzy reasoning component represented by P_0P_7 with two fuzzy reasoning components represented by P_0P_5 and P_5P_7 . In so doing, a pair of *correction rates* c^- and c^+ are introduced, denoted by (c^-, c^+) . Here, c^- represents the modification rate of those interpolated rules whose antecedents are on the left side of the antecedent value of the original (to be modified) interpolated rule (those from A_2^* to A_{j-1}^* in Fig. 11), while c^+ represents the same for those right located interpolated rules (those from A_{j+1}^* to A_{n-1}^* in Fig. 11). The method for computing a correction rate pair is described below.

As illustrated in Fig. 11, if the logical consequence of the middle-most antecedent A_j^* has been modified from B_j^* to \widehat{B}_j^* (i.e. from point p_2 to point p_5), the logical consequence of any antecedent A_i^* located between A_1 and A_j^* is accordingly modified from B_i^* to \widehat{B}_i^* (i.e. from p_1 to p_4). That is, if the antecedent variable takes a value between A_1 and A_j^* , the interpolating mapping line (between the antecedent variable and the consequent variable) is modified from the line segment p_0p_2 to p_0p_5 . For any given antecedent value A_i^* lying between A_1 and A_j^* , the ratio of the distance between B_1 and the modified consequence \widehat{B}_i^* to the distance between B_1 and the original unmodified consequence B_i^* is a constant. It is this ratio that is represented by the correction rate c^- . c^+ is computed in exactly the same way, but replacing the left base rule consequence B_1 with the right base rule consequence B_n .

Formally, the *correction rate* pair (c^-, c^+) are defined as:

$$c^- = \frac{d(B_1, \widehat{B}_j^*)}{d(B_1, B_j^*)}; \quad c^+ = \frac{d(\widehat{B}_j^*, B_n)}{d(B_j^*, B_n)}. \quad (29)$$

From (7) and (29), it follows that:

$$\begin{aligned} c^- &= \frac{d(B_1, \widehat{B}_j^*)}{d(B_1, B_j^*)} = \frac{\frac{d(B_1, \widehat{B}_j^*)}{d(B_1, B_n)}}{\frac{d(B_1, B_j^*)}{d(B_1, B_n)}} = \frac{\lambda_{\widehat{B}_j^*}}{\lambda_{B_j^*}}; \\ c^+ &= \frac{d(\widehat{B}_j^*, B_n)}{d(B_j^*, B_n)} = \frac{d(B_1, B_n) - d(B_1, \widehat{B}_j^*)}{d(B_1, B_n) - d(B_1, B_j^*)} \\ &= \frac{\frac{d(B_1, B_n) - d(B_1, \widehat{B}_j^*)}{d(B_1, B_n)}}{\frac{d(B_1, B_n) - d(B_1, B_j^*)}{d(B_1, B_n)}} = \frac{1 - \lambda_{\widehat{B}_j^*}}{1 - \lambda_{B_j^*}}. \end{aligned} \quad (30)$$

For any given antecedent A_i^* ($2 \leq i \leq j-1$), which is located on the left side of A_j^* , its consequence B_i^* is modified to \widehat{B}_i^* , whose corresponding *relative placement factor* $\lambda_{\widehat{B}_i^*}$ satisfies:

$$\lambda_{\widehat{B}_i^*} = \lambda_{B_i^*} \cdot c^-. \quad (31)$$

Similarly, for any antecedent A_k^* ($j+1 \leq k \leq n-1$), which is on the right side of A_j^* , the corresponding *relative placement factor* $\lambda_{\widehat{B}_k^*}$ of its modified consequence \widehat{B}_k^* satisfies:

$$1 - \lambda_{\widehat{B}_k^*} = (1 - \lambda_{B_k^*}) \cdot c^+. \quad (32)$$

Example 4.2: Continue the running example. Because fuzzy set B_1^* is located nearer the middle than B^* , the culprit interpolated rule IR_1 will be modified first. Suppose that the *relative placement factor* of the modified consequence is $\lambda_{\widehat{C}_1^*}$. Then, the correction rate pair are:

$$c_{R_3 R_4}^- = \frac{\lambda_{\widehat{C}_1^*}}{\lambda_{C_1^*}}; \quad c_{R_3 R_4}^+ = \frac{1 - \lambda_{\widehat{C}_1^*}}{1 - \lambda_{C_1^*}}.$$

Accordingly, IR_2 should be modified with respect to the generated *correction rate* pair $(c_{R_3 R_4}^-, c_{R_3 R_4}^+)$. The *relative placement factor* $\lambda_{\widehat{C}_2^*}$ of the modified consequence satisfies:

$$\lambda_{\widehat{C}_2^*} = \lambda_{C_2^*} \cdot c_{R_3 R_4}^-.$$

The modified interpolated rule consequences \widehat{C}_1^* and \widehat{C}_2^* can thus be expressed as follows:

$$\begin{aligned} \widehat{C}_1^{*'} &= (1 - \lambda_{\widehat{C}_1^*})C_3 + \lambda_{\widehat{C}_1^*}C_4; \\ \widehat{C}_2^{*'} &= (1 - \lambda_{\widehat{C}_2^*})C_3 + \lambda_{\widehat{C}_2^*}C_4; \\ T(\widehat{C}_1^{*'}, \widehat{C}_1^*) &= T(B_1^{*'}, B_1^*); \\ T(\widehat{C}_2^{*'}, \widehat{C}_2^*) &= T(B^{*'}, B^*). \end{aligned}$$

2) *Consistency of modified propositions:* This requirement ensures that the consequence of each modified interpolated rule is at least $(1 - \beta_0)$ -consistent with the current context. In general, suppose that m object values A_1, A_2, \dots, A_m are obtained for variable x . If they are $(1 - \beta_0)$ -consistent, the matching degree between any pair of these object values is not higher than the given β_0 . In accordance with the concept of contradictory degree (as introduced previously), this requirement can be expressed as follows:

$$\max(1 - M(A_i, A_j)) \leq \beta_0, \quad (33)$$

where $i, j \in \{1, 2, \dots, m\} (i \neq j)$.

Particularly, in the case of using the *set theory-based* similarity measure, if the intersection point between two fuzzy sets is lower than β_0 , the contradictory degree between them is higher than β_0 . There is an equivalent way to represent a β_0 -contradiction by using β_0 -cut due to the convexity of the fuzzy sets considered herein. If the intersection of β_0 -cuts of two fuzzy sets is empty, the contradictory degree between them is higher than β_0 . This indicates that the contradictory degree of fuzzy sets concerning a common variable can be calculated according to their membership functions. Therefore, Eq. 33 can be simplified as follows:

$$\bigcap_{i=1}^m (A_i)_{\beta_0} \neq \emptyset, \quad (34)$$

where $(A_i)_{\beta_0}$ denotes the β_0 -cut of fuzzy set A_i .

Example 4.3: For the running example, fuzzy sets \widehat{C}_1^* and \widehat{C}_2^* must satisfy the following constraints with respect to this requirement:

$$1 - M(\widehat{C}_1^*, \widehat{C}_2^*) \leq \beta_0.$$

Specifically, if the *set theory-based* similarity measure given by Eq. 23 is used for this example, the requirement can be expressed as follows:

$$(\widehat{C}_1^*)_{\beta_0} \cap (\widehat{C}_2^*)_{\beta_0} \neq \emptyset.$$

3) *Consistency over modified proposition propagation:* Every modified value of a given variable is propagated through all possible subsequent interpolations that depend on that variable, as dictated by the dependencies recorded by the ATMS. The corresponding propositions of such updated values are required to be $(1 - \beta_0)$ -consistent. The propagation process follows the standard transformation-based interpolation approach strictly.

For simplicity, let function $I(A_i^*, R_l R_r) = B_i^*$ denote the transformation-based interpolation from the antecedent fuzzy set A_i^* to the consequent value B_i^* , based on the fuzzy reasoning component involving the neighboring rules R_l and R_r . Suppose that m object values $A_1^*, A_2^*, \dots, A_m^*$ of variable x are modified which are located between the antecedent values of rules R_l and R_r , that the corresponding modified object values of variable y are B_i^* , $i \in \{1, 2, \dots, m\}$, and that n object values B_l , $l \in \{1, 2, \dots, n\}$, of variable y are already obtained by one way or another. If the modified consequences \widehat{B}_i^* are all $(1 - \beta_0)$ -consistent, then they must satisfy:

$$\begin{aligned} \widehat{B}_i^* &= I(\widehat{A}_i^*, R_l R_r), \\ \max(1 - M(\widehat{B}_u^*, \widehat{B}_v^*)) &\leq \beta_0, \\ \max(1 - M(\widehat{B}_i^*, B_l)) &\leq \beta_0, \\ \max(1 - M(B_p, B_q)) &\leq \beta_0, \end{aligned} \quad (35)$$

where $u, v \in \{1, 2, \dots, m\} (u \neq v)$; $p, q \in \{1, 2, \dots, n\} (p \neq q)$. Specifically, if the *set theory-based* similarity measure given by Eq. 23 is used, this can be simplified as follows:

$$\begin{aligned} \widehat{B}_i^* &= I(\widehat{A}_i^*, R_l R_r); \\ \left(\bigcap_{i=1}^m (\widehat{B}_i^*)_{\beta_0} \right) \cap \left(\bigcap_{l=1}^n (B_l)_{\beta_0} \right) &\neq \emptyset. \end{aligned} \quad (36)$$

The above discussion addresses the situation where modified proposition propagation is restricted to single-antecedent rules.

This can be readily generalized to multiple-antecedent rules. Let function $I((A_i^*, B_i^*, C_i^*, \dots), R_l R_r) = Z_i^*$ denote the transformation-based interpolation from the antecedent fuzzy sets $(A_i^*, B_i^*, C_i^*, \dots)$ to the consequent value Z_i^* , based on the fuzzy reasoning component involving neighboring rules R_l and R_r . The consequence Z_i^* needs to be accordingly modified if any fuzzy set of $(A_i^*, B_i^*, C_i^*, \dots)$ has been modified such that the modified $(A_i^*, B_i^*, C_i^*, \dots)$ is flanked by the neighboring rules R_l and R_r . If the modified consequences are all $(1 - \beta_0)$ -consistent, the contradictory degree of every pair of fuzzy sets with respect to the consequent variable must be less than or equal to β_0 , no matter whether they are modified or not.

Example 4.4: Continue the running example, the modified fuzzy sets \hat{C}_1^* and \hat{C}_2^* of variable x_3 need to be propagated in order to modify the subsequent variables x_5 , x_6 and x_7 . Since the *set theory-based* similarity measure has been used in this example previously, the propagated object values of variable x_5 must satisfy the following equations simultaneously:

$$\begin{aligned}\hat{E}_1^* &= I((\hat{C}_1^*, D^*), R_7 R_8); \\ \hat{E}_2^* &= I((\hat{C}_2^*, D^*), R_7 R_8); \\ (\hat{E}_1^*)_{\beta_0} \cap (\hat{E}_2^*)_{\beta_0} &\neq \emptyset.\end{aligned}$$

Similarly, for the object values of variable x_6 , they must satisfy:

$$\begin{aligned}\hat{F}_1^* &= I(\hat{C}_1^*, R_5 R_6); \\ \hat{F}_2^* &= I(\hat{C}_2^*, R_5 R_6); \\ (\hat{F}_1^*)_{\beta_0} \cap (\hat{F}_2^*)_{\beta_0} \cap (F^*)_{\beta_0} &\neq \emptyset.\end{aligned}$$

Also, for the object values of variable x_7 , the following equations need to be satisfied:

$$\begin{aligned}\hat{G}_1^* &= I(\hat{F}_1^*, R_9 R_{10}); \\ \hat{G}_2^* &= I(\hat{F}_2^*, R_9 R_{10}); \\ \hat{G}_3^* &= I(\hat{E}_2^*, R_{11} R_{12}); \\ \hat{G}_4^* &= I(\hat{E}_1^*, R_{11} R_{12}); \\ \cap_{j=1}^4 (\hat{G}_j^*)_{\beta_0} \cap (G_3^*)_{\beta_0} &\neq \emptyset.\end{aligned}$$

4) *Combination of correction requirement criteria:* As described above, each requirement induces a set of constraining equations over the interpolation. For a detected inconsistency, all such induced equations must be satisfied simultaneously. If there exists at least one solution for these equations, the candidate has been modified successfully. Otherwise, this candidate is discarded and the next one of the smallest cardinality will be tried as indicated in the algorithm given in Section IV-A.

Example 4.5: For the running example, with respect to candidate C_1 , no solution is arrived at by solving all the equations listed above simultaneously, which means the modification to C_1 has failed. Therefore, candidate C_1 is discarded and C_2 is then taken for tentative modification, but the modification to C_2 also fails (the derivation of this is omitted here due to space limitations). Thus C_3 needs to be modified. Notice that there are multiple-premise rules involved in candidate C_3 , the modification of which is not covered by the approach introduced above. However, the present approach is readily extendable to deal with this, which is introduced in the next subsection.

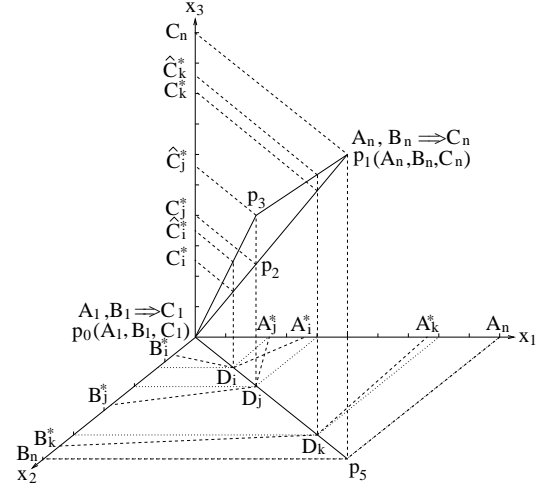

Fig. 12. Multiple-premise-based defective reasoning component modification

C. Multiple-premise-based defective reasoning component correction

The problem space of n -antecedent ($n \geq 1$) rule interpolation is $(n + 1)$ -dimensional. Without losing generality, for simplicity, two-antecedent rules are taken here to illustrate the underlying approach. Suppose that $(A_2^*, B_2^*), (A_3^*, B_3^*), \dots, (A_{n-1}^*, B_{n-1}^*)$ are observations, and that the neighboring rules $A_1, B_1 \Rightarrow C_1$ and $A_n, B_n \Rightarrow C_n$ flank all these observations. Similar to the single-antecedent rule interpolation as illustrated in Fig. 11, in computing interpolation involving two antecedent variables, a linear relation is assumed between the antecedent variables and the corresponding consequent variable. This can be represented by a line in a 3-dimensional space (line P_0P_1 in Fig. 12) if fuzzy sets are expressed using their *representative values*. Line P_0P_5 , the projection of line P_0P_1 onto plane x_1x_2 , provides a partial order amongst all possible antecedent value pairs of variables x_1 and x_2 . In particular, as shown in Fig. 12, observations $(A_i^*, B_i^*), (A_j^*, B_j^*)$ and (A_k^*, B_k^*) are mapped onto points D_i, D_j and D_k , respectively, on the line P_0P_5 . This is done by the combined *relative placement factor* $\lambda_{C_j^*}$ ($l \in \{2, 3, \dots, n-1\}$) calculated from $\lambda_{A_l^*}$ and $\lambda_{B_l^*}$ (Eq. 19).

Assume that D_j ($2 \leq j \leq n-1$) sits in the location which is the middle-most amongst all the observations on the line P_0P_5 . Then, interpolated rule $(A_j^*, B_j^*) \Rightarrow C_j^*$ will be modified first. The modification breaks the straight interpolation line P_0P_1 into two connected straight line segments P_0P_3 and P_3P_1 as shown in Fig. 12. The effect of this modification method is to refine the defective fuzzy reasoning component by dividing it into two more accurate fuzzy reasoning components. This corresponds to refining the fuzzy reasoning component represented by P_0P_1 into two represented by P_0P_3 and P_3P_1 .

For consistency, all interpolated rules based on the original defective fuzzy reasoning component need to be modified by the two replacement fuzzy reasoning components. This can be done conveniently thanks to the *correction rate* pair defined in Eq. 29. In particular, c^- represents the modification rate of those interpolated rules whose antecedents are less than the antecedent of the first modified rule (i.e. (A_j^*, B_j^*)) by the

partial order, and c^+ represents the same for the greater ones. That is, c^- measures the difference of the interpolated results by interpolation lines P_0P_2 and P_0P_3 from those antecedent pairs which are greater than (A_1, B_1) and less than (A_j^*, B_j^*) according to the partial order, while c^+ does the same but by interpolation lines P_2P_1 and P_3P_1 from those pairs which are between (A_j^*, B_j^*) and (A_n, B_n) . Having calculated the unique *correction rate* pair for each fuzzy reasoning component, a set of constraints can be set up in exactly the same way as that for single-premise situation outlined in Sec. IV-B. The modification result is then computed by solving these constraints simultaneously.

Several factors affect the complexity of these constraints: the maximal number of variables involved in a constraint is equal to the number of premises of rules; the number of constraints depends on the lengths of the reasoning chains that need to be modified; and the order of all these equations or inequations is the highest order of functions f_i ($i \in \{1, 2, \dots, 7\}$) as illustrated in Fig. 4. In particular, for the scale and move transformation-based approach, the highest order is 2, largely due to the complexity of the transformation functions f_4 and f_5 . Therefore, the complexity of the proposed modification algorithm is equivalent to the complexity of solving this set of inequations and equations. Because there is no standard algorithm for solving such problems, different methods may be applied. These include continuous Constraint Satisfaction Problem techniques [59] and stochastic approaches [33]. Accordingly, the complexity varies significantly. However, for fuzzy reasoning applications (e.g. systems control and diagnosis), the interpolation chain is usually not very long and (symmetric) fuzzy numbers are quite often used to specify quantity spaces. Therefore, the set of constraints can be reduced to a linear inequality problem. In this case, polynomial time complexity is guaranteed [1].

Example 4.6: Continue the running example, four rules have been interpolated through the two fuzzy reasoning components that comprise the candidate C_3 :

IR_3 : If x_3 is C_1^* and x_4 is D^* , then x_5 is E_1^* ;

IR_5 : If x_3 is C_1^* , then x_6 is F_1^* ;

IR_4 : If x_3 is C_2^* and x_4 is D^* , then x_5 is E_2^* ;

IR_6 : If x_3 is C_2^* , then x_6 is F_2^* .

For a given candidate, the modification is a process to set up a set of simultaneous equations and inequations. The solution of these equations and inequations leads to the end result of the modification to the candidate (unless there is no solution for the set of equations). For candidate C_3 , both fuzzy reasoning components R_5R_6 and R_7R_8 need to be modified, by setting up simultaneous equations and inequations jointly. Since the solution of a set of simultaneous equations is irrelevant to the order of its equations, the result of the modification for a candidate is irrelevant to the order of handling its fuzzy reasoning components. That is, either R_5R_6 and R_7R_8 can be taken for modification first. In this example, R_7R_8 is arbitrarily taken first. Following the requirement of Section IV-C, the modification starts from the interpolated rule IR_3 . Assume that the *relative placement factor* of the consequence of IR_3 is modified to $\lambda_{\hat{E}_1^*}$, the *correction rate* pair (c^-, c^+) for the culprit fuzzy reasoning component R_7R_8 can be calculated as

follows:

$$c_{R_7R_8}^- = \frac{\lambda_{\hat{E}_1^*}}{\lambda_{E_1^*}}; \quad c_{R_7R_8}^+ = \frac{1 - \lambda_{\hat{E}_1^*}}{1 - \lambda_{E_1^*}}.$$

The *relative placement factor* $\lambda_{\hat{E}_2^*}$ (of the modified consequence \hat{E}_2^* of IR_4) is computed according to Eq. 31, such that $\lambda_{\hat{E}_2^*} = \lambda_{E_2^*} \cdot c_{R_7R_8}^-$. With such assumed *relative placement factors*, fuzzy sets \hat{E}_1^* and \hat{E}_2^* are calculated by:

$$\begin{aligned} \hat{E}_1^* &= (1 - \lambda_{\hat{E}_1^*})E_7 + \lambda_{\hat{E}_1^*}E_8; \\ T(\hat{E}_1^*, \hat{E}_1^*) &= T((C_1^*, D^*), (C_1^*, D^*)); \\ \hat{E}_2^* &= (1 - \lambda_{\hat{E}_2^*})E_7 + \lambda_{\hat{E}_2^*}E_8; \\ T(\hat{E}_2^*, \hat{E}_2^*) &= T((C_2^*, D^*), (C_2^*, D^*)). \end{aligned}$$

As C_2^* is located nearer the middle than C_1^* , the modification for fuzzy reasoning component R_5R_6 starts from the interpolated rule IR_6 . Similarly, assume that the *relative placement factor* of the consequence of IR_6 is modified to $\lambda_{\hat{F}_2^*}$, then the following equations can be set for those interpolated rules which are based on fuzzy reasoning component R_5R_6 according to the requirement of Section IV-B1:

$$\begin{aligned} c_{R_5R_6}^- &= \frac{\lambda_{\hat{F}_2^*}}{\lambda_{F_2^*}}; \\ c_{R_5R_6}^+ &= \frac{1 - \lambda_{\hat{F}_2^*}}{1 - \lambda_{F_2^*}}; \\ (1 - \lambda_{\hat{F}_1^*}) &= (1 - \lambda_{F_1^*}) \cdot c_{R_5R_6}^+; \\ \hat{F}_1^* &= (1 - \lambda_{\hat{F}_1^*})F_5 + \lambda_{\hat{F}_1^*}F_6; \\ \hat{F}_2^* &= (1 - \lambda_{\hat{F}_2^*})F_5 + \lambda_{\hat{F}_2^*}F_6; \\ T(\hat{F}_1^*, \hat{F}_1^*) &= T(C_1^*, C_1^*); \\ T(\hat{F}_2^*, \hat{F}_2^*) &= T(C_2^*, C_2^*). \end{aligned}$$

Requirements given in Sections IV-B2 and IV-B3 ensure that the modified propositions and their propagation are $(1 - \beta_0)$ -consistent. Because of the use of the *set theory-based* similarity measure in the example, this can be expressed as:

$$\begin{aligned} (\hat{E}_1^*)_{\beta_0} \cap (\hat{E}_2^*)_{\beta_0} &\neq \emptyset; \\ (\hat{F}_1^*)_{\beta_0} \cap (\hat{F}_2^*)_{\beta_0} \cap (F^*)_{\beta_0} &\neq \emptyset; \\ \hat{G}_1^* &= I(\hat{F}_1^*, R_9R_{10}); \\ \hat{G}_2^* &= I(\hat{F}_2^*, R_9R_{10}); \\ \hat{G}_3^* &= I(\hat{E}_2^*, R_{11}R_{12}); \\ \hat{G}_4^* &= I(\hat{E}_1^*, R_{11}R_{12}); \\ \bigcap_{j=1}^4 (\hat{G}_j^*)_{\beta_0} \cap (G_3^*)_{\beta_0} &\neq \emptyset. \end{aligned}$$

Solving these simultaneous equations and inequations leads to one solution which is illustrated in Fig. 13. It is clear from this result that there is no β_0 -contradiction any more and thus consistency has been restored. This means that the original inconsistent interpolation process has been corrected with consistent interpolated results throughout.

V. APPLICATION TO DIARRHEAL DISEASE PREDICTION

It is well known that environmental change influences disease burden [16], [48]. In particular, intensive studies have been conducted in an effort to identify the logical relationship underlying such influences in order to build models that may

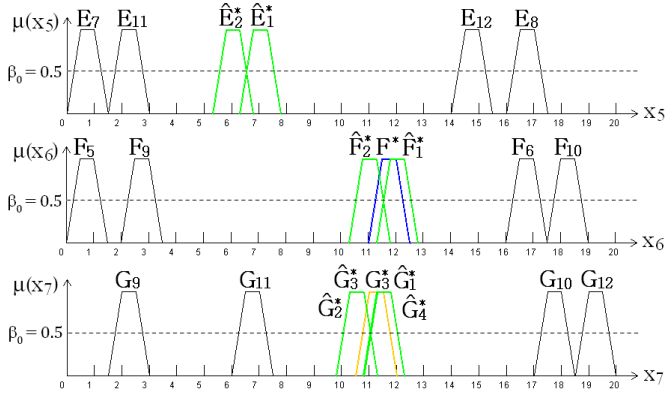

Fig. 13. The solution for the running example

predict the consequence of environmental change events. Such models can be used to predict the diarrheal disease rate in a village. The prediction is of policy importance. For example, when the World Bank makes decisions about whether to invest or how best to proceed in large-scale infrastructure projects, their impact assessments have begun to pay attention to variables associated with environmental, social and health factors [61].

Models built this way are often very complicated as there are many factors affecting the relationship which are not linearly related, but typically interact with each other in a grid network. Consequently, problems in this domain may only be partially learned or comprehended, which implies that solutions to such problems are only derivable from a sparse knowledge base. In addition, the factors concerned are usually difficult, if not impossible, to be precisely measured or represented. Therefore, such problems provide a potentially suitable testbed for fuzzy interpolation techniques. Four existing fuzzy interpolation approaches and the adaptive fuzzy interpolation proposed above will be applied below to a specific problem in this area.

A. Problem specification

The particular application problem considered here is based on the study of [32]. It addresses the issue of measuring how the construction of a new road or railway in a previously roadless area may affect the epidemiology of infectious diseases in northern coastal Ecuador. A causal diagram has been developed which captures the insight relationship between the key factors driven by road construction, as illustrated in Fig. 14. This causal diagram shows that the diarrheal disease rate of a village is affected by its remoteness in two ways: (a) Localized migration facilitated by roads can lead to a community whose residents have few social connections, which tends to lead to failure in creating adequate water and sanitation infrastructure because the residents are unlikely to know one another well and share social norms [3], [35], [40]. (b) Road proximity can increase the contact between the residents within a village and those outside of the village, thereby increasing the rate of introduction of pathogens and raising the diarrheal disease rate.

As a demonstrative example, the object value of “remoteness” is herein reasonably assume to be causally determined by two factors [32]: the distance to the closest town and the connectivity level to modern transportation systems. There are two kinds of land ways considered, railway and road. The connectivity level to modern transportation systems is therefore dependent on the connectivity situation to the nearest railway station and road. The overall causal network model used in this example is shown in Fig. 15.

B. Knowledge representation and model construction

All the factors considered in this example are represented as variables and each relation between any two directly connected factors is represented as a rule containing the relevant variables. Note that different variables are defined on different domains. To simplify knowledge representation, variable domains are mapped onto the real line and normalized. For instance, suppose that the maximum distance between any village amongst all the villages considered and its nearest town is 200 kilometers (KM), then the domain of variable “distance to the nearest town” is from 0KM to 200KM. If there is a village which is about 100KM away from its nearest town, the vague term “about 100KM” can be represented as a trapezoidal fuzzy set (94KM, 98KM, 102KM, 106KM). After mapping this variable domain onto the real line and normalization, the vague term “about 100KM” is then represented as (0.47, 0.49, 0.51, 0.53).

The procedures of building the rule base and defining the fuzzy sets (the object values of the domain variables) are omitted here to save space. There are eleven variables in the problem, denoted as x_i , $i \in \{1, 2, \dots, 11\}$, which are listed in Table I. Note that only part of the constructed rule base is directly employed in this example, including those rules which flank an observation or a previously interpolated result. These rules are given below, with those object values used within the rules all represented as trapezoidal fuzzy sets and also listed in Table I:

- R_1 : If x_1 is A_1 and x_2 is B_1 , then x_3 is C_1 ;
- R_2 : If x_1 is A_2 and x_2 is B_2 , then x_3 is C_2 ;
- R_3 : If x_3 is C_3 and x_4 is D_3 , then x_5 is E_3 ;
- R_4 : If x_3 is C_4 and x_4 is D_4 , then x_5 is E_4 ;
- R_5 : If x_5 is E_5 , then x_6 is F_5 ;
- R_6 : If x_5 is E_6 , then x_6 is F_6 ;
- R_7 : If x_6 is F_7 , then x_7 is G_7 ;
- R_8 : If x_6 is F_8 , then x_7 is G_8 ;
- R_9 : If x_5 is E_9 , then x_8 is H_9 ;
- R_{10} : If x_5 is E_{10} , then x_8 is H_{10} ;
- R_{11} : If x_8 is H_{11} , then x_9 is I_{11} ;
- R_{12} : If x_8 is H_{12} , then x_9 is I_{12} ;
- R_{13} : If x_9 is I_{13} , then x_{10} is J_{13} ;
- R_{14} : If x_9 is I_{14} , then x_{10} is J_{14} ;
- R_{15} : If x_7 is G_{15} and x_{10} is J_{15} , then x_{11} is K_{15} ;
- R_{16} : If x_7 is G_{16} and x_{10} is J_{16} , then x_{11} is K_{16} .

C. Application of fuzzy interpolation

Suppose that the diarrheal disease rate of a village needs to be estimated based on several pieces of information

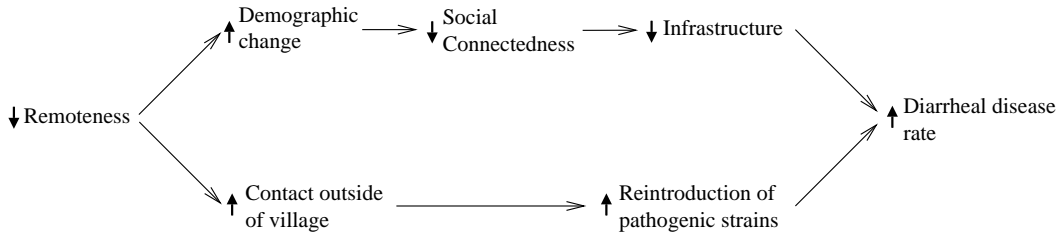

Fig. 14. Causal diagram between remoteness and diarrheal disease rate

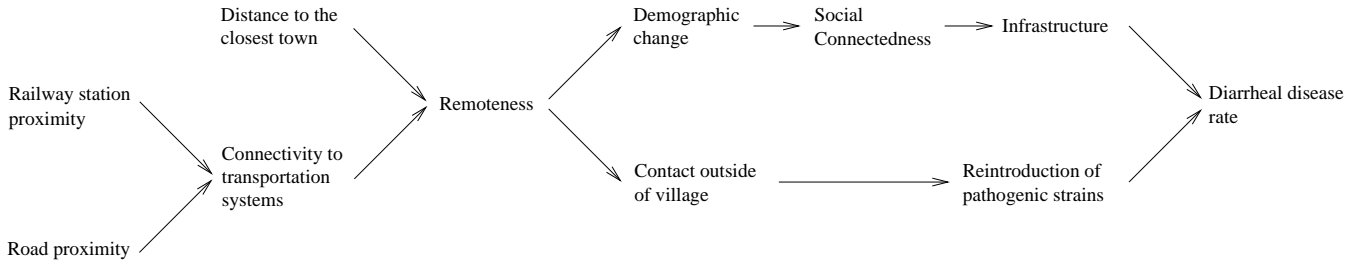

Fig. 15. The causal network model used

TABLE I
FUZZY VARIABLES AND THEIR NORMALIZED OBJECT VALUES

Var	Meaning	Object value
x_1	Railway station proximity	$A_1 = \{0.02, 0.04, 0.06, 0.08\}$; $A_2 = \{0.28, 0.30, 0.32, 0.34\}$
x_2	Road proximity	$B_1 = \{0.18, 0.20, 0.22, 0.24\}$; $B_2 = \{0.39, 0.41, 0.43, 0.45\}$
x_3	Connectivity to transportation systems	$C_1 = \{0.46, 0.48, 0.50, 0.52\}$; $C_2 = \{0.62, 0.64, 0.66, 0.68\}$ $C_3 = \{0.52, 0.54, 0.56, 0.58\}$; $C_4 = \{0.85, 0.87, 0.89, 0.91\}$
x_4	Distance to the closest town	$D_3 = \{0.52, 0.54, 0.56, 0.58\}$; $D_4 = \{0.82, 0.84, 0.86, 0.88\}$
x_5	Remoteness	$E_3 = \{0.41, 0.43, 0.45, 0.47\}$; $E_4 = \{0.72, 0.74, 0.76, 0.78\}$ $E_5 = \{0.27, 0.29, 0.31, 0.33\}$; $E_6 = \{0.58, 0.60, 0.62, 0.64\}$ $E_9 = \{0.39, 0.41, 0.43, 0.45\}$; $E_{10} = \{0.62, 0.64, 0.66, 0.68\}$
x_6	Contact outside of the community	$F_5 = \{0.62, 0.64, 0.66, 0.68\}$; $F_6 = \{0.30, 0.32, 0.34, 0.36\}$ $F_7 = \{0.38, 0.40, 0.42, 0.44\}$; $F_8 = \{0.70, 0.72, 0.74, 0.76\}$
x_7	Reintroduction of pathogenic strains	$G_7 = \{0.46, 0.48, 0.50, 0.52\}$; $G_8 = \{0.65, 0.67, 0.69, 0.71\}$ $G_{15} = \{0.30, 0.32, 0.34, 0.36\}$; $G_{16} = \{0.60, 0.62, 0.64, 0.66\}$
x_8	Demographic changes	$H_9 = \{0.60, 0.62, 0.64, 0.66\}$; $H_{10} = \{0.30, 0.32, 0.34, 0.36\}$ $H_{11} = \{0.46, 0.48, 0.50, 0.52\}$; $H_{12} = \{0.68, 0.70, 0.72, 0.74\}$
x_9	Social connectedness	$I_{11} = \{0.52, 0.54, 0.56, 0.58\}$; $I_{12} = \{0.20, 0.22, 0.24, 0.26\}$ $I_{13} = \{0.28, 0.30, 0.32, 0.34\}$; $I_{14} = \{0.55, 0.57, 0.59, 0.61\}$
x_{10}	Hygiene and sanitation infrastructure	$J_{13} = \{0.26, 0.28, 0.30, 0.32\}$; $J_{14} = \{0.61, 0.63, 0.65, 0.67\}$ $J_{15} = \{0.36, 0.38, 0.40, 0.42\}$; $J_{16} = \{0.58, 0.60, 0.62, 0.64\}$
x_{11}	Infectious disease rates	$K_{15} = \{0.18, 0.20, 0.22, 0.24\}$; $K_{16} = \{0.68, 0.70, 0.72, 0.74\}$

which have been obtained by different agencies. These pieces of information are expressed as observations, which are: $x_1 = A^* = (0.16, 0.18, 0.20, 0.22)$, $x_2 = B^* = (0.34, 0.36, 0.38, 0.40)$, $x_4 = D^* = (0.65, 0.67, 0.69, 0.71)$, and $x_8 = H^* = (0.54, 0.56, 0.58, 0.60)$. Note that all the left closest and right closest rules to each observation have been explicitly presented above. Given the sparse rule base, none of these observations overlap with any rule antecedent. This means that the problem cannot be solved by ordinary fuzzy inference techniques. In such a situation, fuzzy rule

interpolation has a natural appeal. In particular, four fuzzy rule interpolation methods are applied to the problem for comparison purposes, which are KH [44], KH stabilized [57], HS [37] and MACI [56]. The interpolated object values for variables x_9 , x_{10} and x_{11} by these approaches are shown in Figs. 16 - 19 (they are generated using the FRI Toolbox [41] and the in-house HS program).

If set-theory-based similarity measure given by Eq. 23 is utilized to calculate the contradictory degree and let $\beta_0 = 0.5$, it is obvious that β_0 -inconsistencies will result from all these

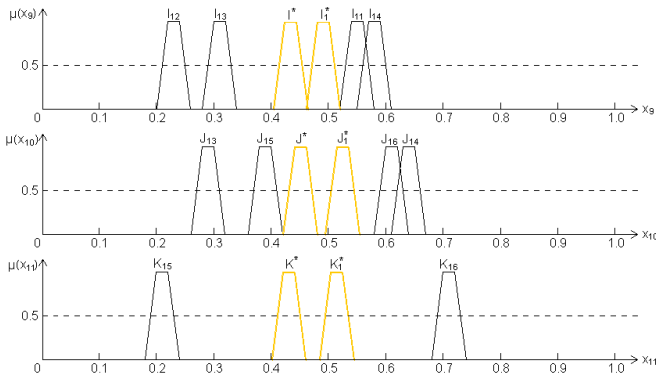

Fig. 16. Interpolated result by the HS method

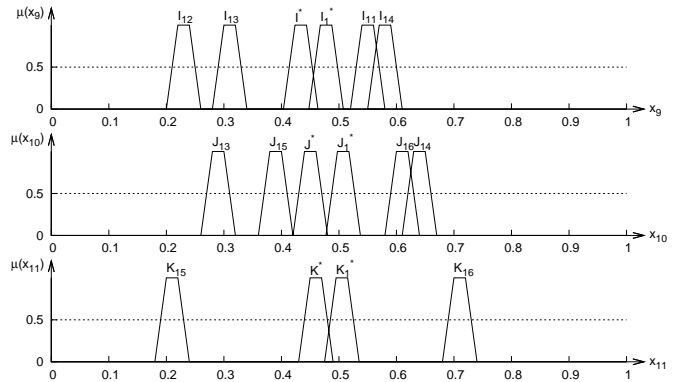

Fig. 17. Interpolated result by the KH method

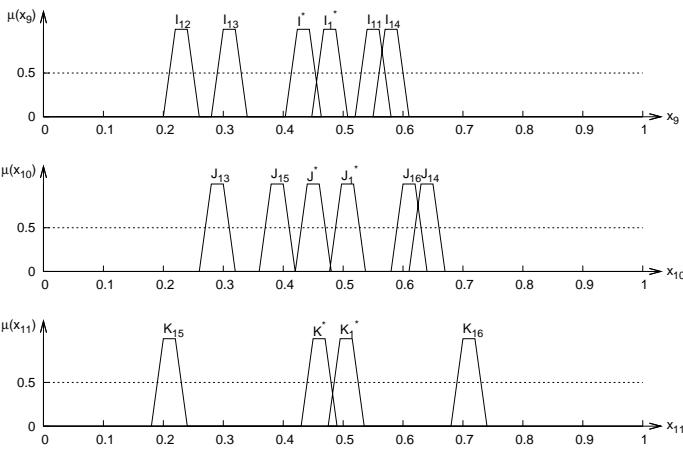

Fig. 18. Interpolated result by the KH stabilized method

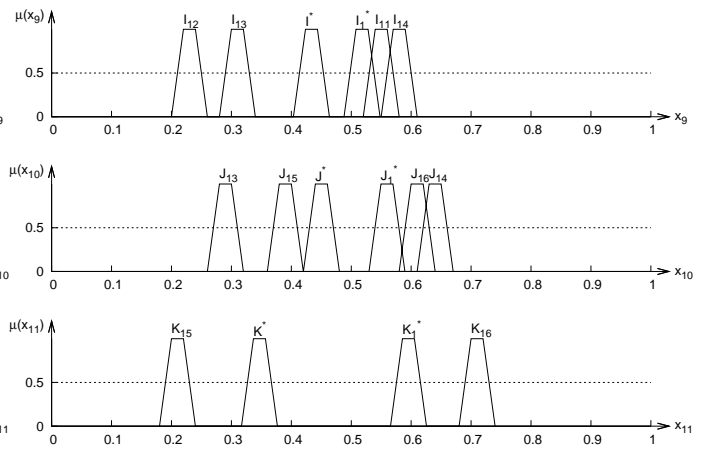

Fig. 19. Interpolated result by the MACI method

interpolation methods.

D. Application of adaptive fuzzy interpolation

In order to arrive at a consistent solution, the proposed adaptive fuzzy interpolation approach is then applied. The overhead is the requirement of defining all the fuzzy reasoning components involved in the problem. Fortunately, this is made straightforward by mapping the causal network of Fig. 15 onto a component-based diagram. For the current problem, there are 8 fuzzy reasoning components which are linked as illustrated in Fig. 20.

From the fuzzy reasoning components upon which the detected contradictions depend, which are recorded in the ATMS network, four minimal candidates are generated by the GDE: $C_1 = [F_1]$, $C_2 = [F_2]$, $C_3 = [F_5]$ and $C_4 = [F_6]$. One of the solutions resulted from the modification of candidate C_4 is shown in Fig. 21.

From this figure, it can be seen that the interpolated result by the proposed adaptive approach is consistent, which demonstrates the potential of the present work. Note that although the adaptive approach is built on the basis of the scale and move transformation-based fuzzy interpolation method in this paper, as argued earlier, it may also be utilized to support other intermediate rule-based interpolation approaches.

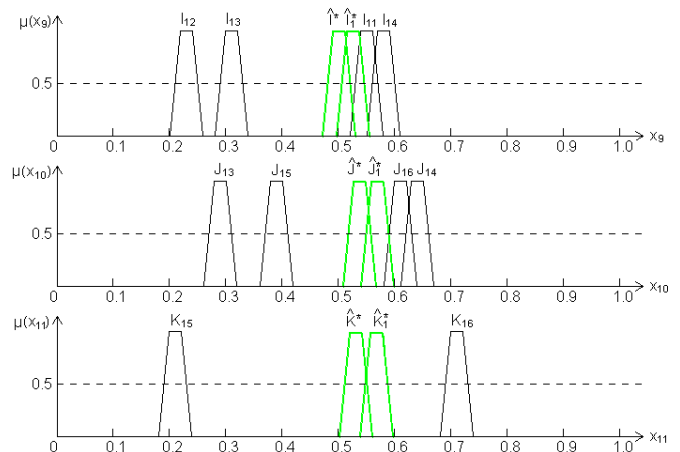

Fig. 21. Interpolated result by the adaptive approach (based on the HS approach)

Of course, in real applications, such a result needs to be mapped back onto its original domain in order to retrieve the real meaning. In particular for this example, the interpolated result by the adaptive approach can be interpreted as about 0.55 in the real domain $[0, 1]$. Suppose that the original domain of variable x_{11} is from 0% to 10%, then the diarrheal disease

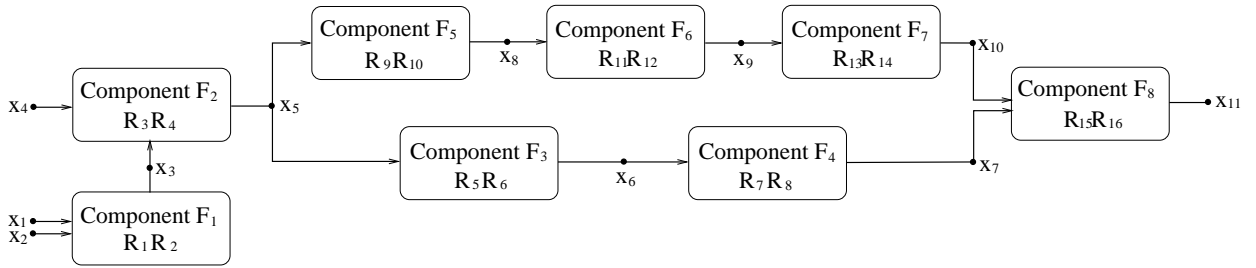

Fig. 20. Component-based diagram of the model

rate is predicated as about 5.5% for the studied village.

VI. CONCLUSIONS

Inconsistency may result after a series of fuzzy interpolations. This paper has made use of popular symbolic AI tools, ATMS and GDE to support fuzzy interpolation by means of efficiently finding and isolating possible faulty interpolated rules which have caused the inconsistency. ATMS records dependencies between interpolated rules and the neighboring rules employed for interpolation, while GDE generates minimal candidates, with each of which explaining the entire set of contradictions in a given situation. The paper has further proposed a method to modify the identified culprit interpolated rules in an effort to restore reasoning consistency. The method works by first extracting the entire set of interpolated rules which depend on the same pair of neighboring rules in the generated candidate list. Then, it imposes a group of equations and inequations which not only constrain the modified propositions and ensure their propagation to be consistent, but also guarantee the original similarity-based reasoning in fuzzy interpolation to be followed. Finally, the approach corrects the culprit interpolated rules by solving the set of simultaneous equations and inequations.

The working of the adaptive approach is illustrated with a practically significant example (running through Sections III and IV) to explain the relevant theoretical concepts. Further, it has been applied to a realistic problem that predicts the diarrheal disease rates in roadless villages. This problem presents itself as a suitable testbed for evaluating fuzzy interpolation techniques due to its nature of lacking detailed information and comprehensive knowledge - there is only a sparse and vague rule base that is available for modeling the problem. Four typical existing fuzzy interpolation approaches and the proposed adaptive approach were applied to this problem, for which the proposed approach results in an improved consistency.

This application has illustrated the potential of the adaptive approach in producing more consistent interpolated results as compared to the original work. An interesting piece of further work is to identify and apply a set of data which would support the comparison between values interpolated using this approach and the underlying ground truth of such data. This will help to better establish the correctness and stability of the present research.

Note that consistency-restoring problem has been addressed in the literature. For instance, the work of [24] has proposed an

approach to transform potentially inconsistent rules by making their consequents more imprecise. Such a technique particularly aims at the type of inconsistency which has resulted from over-tight domain partitions. This work differs from other consistency restoring techniques in that the inconsistency is caused by imprecise modeling, which assumes linear relationships between premises and conclusions. However, it may be of great interest to compare this research with that of influence networks, especially when rules in a clique are taken into account. This remains as active research.

Whilst the proposed work is promising, it relies upon the assumption that all rules for interpolation which are provided in the initial rule base are totally true and fixed. This may not be always the case, despite the fact that it is a common assumption made in the literature of fuzzy interpolation. Thus, further development on the work that allows such rules to become themselves diagnosable and modifiable may be desirable. Also, the work reported herein is applicable to cases where interpolation involves two multi-antecedent rules only. How this may be extended to interpolation with multiple rules and to extrapolation remains an interesting area for further research. Note that initial investigation into such issues has recently been reported [67]. Finally, it is worthwhile to develop a unified inconsistency diagnosis and fault correction mechanism on a fuzzy reasoning platform that implements both standard fuzzy inference and fuzzy interpolation.

ACKNOWLEDGMENT

The authors are very grateful to the reviewers and the Associate Editor for their thorough and constructive comments which have helped in improving this research significantly.

REFERENCES

- [1] B. Aspvall and Y. Shiloach, "A polynomial time algorithm for solving systems of linear inequalities with two variables per inequality," Stanford, CA, USA, Tech. Rep., 1979.
- [2] P. Baranyi, L. T. Kóczy, and T. D. Gedeon, "A generalized concept for fuzzy rule interpolation," *IEEE T. Fuzzy Syst.*, vol. 12, no. 6, pp. 820–837, 2004.
- [3] A. Bebbington and T. Perreault, "Social capital, development, and access to resources in highland ecuador," *Economic Geography*, vol. 75, no. 4, pp. 395–418, 1999.
- [4] R. A. C. Bianchi, A. Ramisa, and R. L. de Mántaras, "Automatic selection of object recognition methods using reinforcement learning," in *Advances in Machine Learning I*, ser. Studies in Computational Intelligence, J. Koronacki, Z. W. Ras, S. T. Wierzbuchon, and J. Kacprzyk, Eds. Springer, 2010, vol. 262, pp. 421–439.
- [5] T. Boongoen, C. Shang, N. Iam-On, and Q. Shen, "Extending data reliability measure to a filter approach for soft subspace clustering," *To appear in IEEE T. Syst., Man and Cybern. B*.

- [6] T. Boongoen and Q. Shen, "Nearest-neighbor guided evaluation of data reliability and its applications," *IEEE T. Syst., Man and Cybern. B*, vol. 40, no. 6, pp. 1622–1633, 2010.
- [7] J. L. Castro and J. M. Zurita, "A generic atms," *Int. J. Approx. Reason.*, vol. 14, no. 4, pp. 259–280, 1996.
- [8] —, "A multivalued logic atms," *Int. J. Intell. Syst.*, vol. 11, no. 4, pp. 185–195, 1996.
- [9] Y.-C. Chang, S.-M. Chen, and C.-J. Liao, "Fuzzy interpolative reasoning for sparse fuzzy-rule-based systems based on the areas of fuzzy sets," *IEEE T. Fuzzy Syst.*, vol. 16, no. 5, pp. 1285–1301, Oct. 2008.
- [10] S.-J. Chen and S.-M. Chen, "Fuzzy risk analysis based on similarity measures of generalized fuzzy numbers," *IEEE T. Fuzzy Syst.*, vol. 11, no. 1, pp. 45–56, Feb 2003.
- [11] S.-M. Chen, "New methods for subjective mental workload assessment and fuzzy risk analysis," *Cyber. Syst.: Int. J.*, vol. 27, no. 5, pp. 449–472, 1996.
- [12] S.-M. Chen and Y.-C. Chang, "Weighted fuzzy rule interpolation based on ga-based weight-learning techniques," *To appear in IEEE T. Fuzzy Syst.*, 2011.
- [13] S.-M. Chen and Y.-K. Ko, "Fuzzy interpolative reasoning for sparse fuzzy rule-based systems based on α -cuts and transformations techniques," *IEEE T. Fuzzy Syst.*, vol. 16, no. 6, pp. 1626–1648, Dec. 2008.
- [14] S.-M. Chen, M.-S. Yeh, and P.-Y. Hsiao, "A comparison of similarity measures of fuzzy values," *Fuzzy Sets Syst.*, vol. 72, no. 1, pp. 79 – 89, 1995.
- [15] S. Cho, O. K. Ersoy, and M. Lehto, "An algorithm to compute the degree of match in fuzzy systems," *Fuzzy Sets Syst.*, vol. 49, no. 3, pp. 285–299, 1992.
- [16] R. R. Colwell, P. R. Epstein, D. Gubler, N. Maynard, A. J. McMichael, J. A. Patz, R. B. Sack, and R. Shope, "Climate change and human health," *Science*, vol. 279, no. 5353, pp. 968–969, 1998.
- [17] C. de Boor, *A practical guide to splines*. Springer, 2001.
- [18] J. de Kleer, "An assumption-based TMS," *Artif. Intell.*, vol. 28, no. 2, pp. 127–162, 1986.
- [19] —, "Extending the atms," *Artif. Intell.*, vol. 28, no. 2, pp. 163–196, 1986.
- [20] —, "Problem solving with the atms," *Artif. Intell.*, vol. 28, no. 2, pp. 197–224, 1986.
- [21] J. de Kleer and B. C. Williams, "Diagnosing multiple faults," *Artif. Intell.*, vol. 32, no. 1, pp. 97–130, 1987.
- [22] Y. Deng, Wen-KangShi, F. Du, and Q. Liu, "A new similarity measure of generalized fuzzy numbers and its application to pattern recognition," *Pattern Recogn. Lett.*, vol. 25, no. 8, pp. 875–883, 2004.
- [23] J. Doyle, "A truth maintenance system," *Artif. Intell.*, vol. 12, no. 3, pp. 231–272, 1979.
- [24] I. Drummond, L. Godo, and S. Sandri, "Restoring consistency in systems of fuzzy gradual rules using similarity relations," in *SBIA '02: Proceedings of the 16th Brazilian Symposium on Artificial Intelligence*. London, UK: Springer-Verlag, 2002, pp. 386–396.
- [25] D. Dubois and H. Prade, "Operations on fuzzy numbers," *Int. J. Syst. Sci.*, vol. 9, pp. 613–626, 1978.
- [26] D. Dubois, J. Lang, and H. Prade, "A possibilistic assumption-based truth maintenance system with uncertain justifications, and its application to belief revision," in *ECAI '90: Workshop on Truth Maintenance Systems*. London, UK: Springer-Verlag, 1991, pp. 87–106.
- [27] D. Dubois and H. Prade, *Fuzzy Sets and Systems : Theory and Applications (Mathematics in Science and Engineering)*. Academic Press, 1980.
- [28] —, "Fuzzy cardinality and the modeling of imprecise quantification," *Fuzzy Sets Syst.*, vol. 16, no. 3, pp. 199 – 230, 1985.
- [29] —, "What are fuzzy rules and how to use them," *Fuzzy Sets Syst.*, vol. 84, no. 2, pp. 169 – 185, 1996.
- [30] —, "Fuzzy sets in approximate reasoning, part 1: Inference with possibility distributions," *Fuzzy Sets Syst.*, vol. 100, no. Supplement 1, pp. 73 – 132, 1999.
- [31] —, "On fuzzy interpolation," *Int. J. Gen. Syst.*, vol. 28, no. 2, pp. 103–114, 1999.
- [32] J. N. S. Eisenberg, W. Cevallos, K. Ponce, K. Levy, S. J. Bates, J. C. Scott, A. Hubbard, N. Vieira, P. Endara, M. Espinel, G. Trueba, L. W. Riley, and J. Trostle, "Environmental change and infectious disease: how new roads affect the transmission of diarrheal pathogens in rural ecuador," *Proc Natl Acad Sci U S A*, vol. 103, no. 51, pp. 19460–5, 2006.
- [33] R. Y. K. Fung, J. Tang, and D. Wang, "Extension of a hybrid genetic algorithm for nonlinear programming problems with equality and inequality constraints," *Comput. Oper. Res.*, vol. 29, no. 3, pp. 261 – 274, 2002.
- [34] R. Goetschel, Jr., and W. Voxman, "Topological properties of fuzzy numbers," *Fuzzy Sets Syst.*, vol. 10, no. 1-3, pp. 87 – 99, 1983.
- [35] C. Grootaert and T. van Bastelaer, *Understanding and Measuring Social Capital: A Multidisciplinary Tool for Practitioners*. World Bank, Washington, DC, 2002.
- [36] W.-H. Hsiao, S.-M. Chen, and C.-H. Lee, "A new interpolative reasoning method in sparse rule-based systems," *Fuzzy Sets Syst.*, vol. 93, no. 1, pp. 17 – 22, 1998.
- [37] Z. Huang and Q. Shen, "Fuzzy interpolative reasoning via scale and move transformations," *IEEE T. Fuzzy Syst.*, vol. 14, no. 2, pp. 340–359, 2006.
- [38] —, "Fuzzy interpolation and extrapolation: a practical approach," *IEEE T. Fuzzy Syst.*, vol. 16, no. 1, pp. 13–28, 2008.
- [39] —, "Preserving piece-wise linearity in fuzzy interpolation," in *Proc. IEEE Int. Conf. Fuzzy Syst.*, 2009, pp. 575–580.
- [40] J. Isham and S. Kahkonen, "Institutional determinants of the impact community-based water services: Evidence from sri lanka and india," Middlebury College, Department of Economics, Middlebury College Working Paper Series 0220, Jun. 2002.
- [41] Z. C. Johanyák, D. Tikk, S. Kovács, and K. W. Wong, "Fuzzy rule interpolation Matlab toolbox – FRI toolbox," in *Proc. IEEE Int. Conf. Fuzzy Syst.*, 2006, pp. 1427–1433.
- [42] L. T. Kóczy and K. Hirota, "Approximate reasoning by linear rule interpolation and general approximation," *Int. J. Approx. Reason.*, vol. 9, no. 3, pp. 197–225, 1993.
- [43] —, "Interpolative reasoning with insufficient evidence in sparse fuzzy rule bases," *Inf. Sci.*, vol. 71, no. 1-2, pp. 169–201, 1993.
- [44] —, "Size reduction by interpolation in fuzzy rule bases," *IEEE T. Syst., Man Cybern.*, vol. 27, no. 1, pp. 14–25, 1997.
- [45] S. Kovás, "Extending the fuzzy rule interpolation "five" by fuzzy observation," in *Computational Intelligence, Theory and Applications*, B. Reusch, Ed. Springer Berlin Heidelberg, 2006, pp. 485–497.
- [46] J. C. Mason and M. G. Cox, Eds., *Algorithms for approximation*. New York, NY, USA: Clarendon Press, 1987.
- [47] C. Mencar and A. Fanelli, "Interpretability constraints for fuzzy information granulation," *Information Sciences*, vol. 178, no. 24, pp. 4585 – 4618, 2008.
- [48] S. S. Morse, "Factors in the emergence of infectious diseases," *Emerg Infect Dis.*, vol. 1, no. 1, pp. 7–15, 1995.
- [49] C. P. Pappis and N. I. Karacapilidis, "A comparative assessment of measures of similarity of fuzzy values," *Fuzzy Sets Syst.*, vol. 56, no. 2, pp. 171–174, 1993.
- [50] W. H. Press, S. A. Teukolsky, W. T. Vetterling, and B. P. Flannery, *Numerical Recipes: The Art of Scientific Computing*. New York, NY, USA: Cambridge University Press, 2007.
- [51] A. L. Ralescu and D. A. Ralescu, "Probability and fuzziness," *Inf. Sci.*, vol. 34, no. 2, pp. 85–92, 1984.
- [52] R. Ros, J. L. Arcos, R. L. de Mántaras, and M. M. Veloso, "A case-based approach for coordinated action selection in robot soccer," *Artif. Intell.*, vol. 173, no. 9-10, pp. 1014–1039, 2009.
- [53] Q. Shen and R. Leitch, "Fuzzy qualitative simulation," *IEEE T. Syst., Man Cybern.*, vol. 23, no. 4, pp. 1038–1061, Jul/Aug 1993.
- [54] Q. Shen and L. Yang, "Extending data reliability measure to a filter approach for soft subspace clustering," *Journal of Advanced Computational Intelligence and Intelligent Informatics*, vol. 15, no. 3, pp. 288–298, 2011.
- [55] Q. Shen and R. Zhao, "A credibilistic approach to assumption-based truth maintenance," *IEEE T. Syst., Man and Cybern. A*, vol. 41, no. 1, pp. 85–96, 2011.
- [56] D. Tikk and P. Baranyi, "Comprehensive analysis of a new fuzzy rule interpolation method," *IEEE T. Fuzzy Syst.*, vol. 8, no. 3, pp. 281–296, Jun 2000.
- [57] D. Tikk, I. Joó, L. Kóczy, P. Várlaki, B. Moser, and T. D. Gedeon, "Stability of interpolative fuzzy kh controllers," *Fuzzy Sets Syst.*, vol. 125, no. 1, pp. 105 – 119, 2002.
- [58] A. Tversky, "Features of similarity," *Psychol. Rev.*, vol. 84, no. 2, pp. 327–352, 1977.
- [59] X.-H. Vu, M.-C. Silaghi, D. Sam-Haroud, and B. Faltings, "Branch-and-prune search strategies for numerical constraint solving," *CoRR*, vol. abs/cs/0512045, 2005.
- [60] K. W. Wong, D. Tikk, T. Gedeon, and L. Kóczy, "Fuzzy rule interpolation for multidimensional input spaces with applications: a case study," *IEEE T. Fuzzy Syst.*, vol. 13, no. 6, pp. 809–819, Dec. 2005.
- [61] World Bank, *Health aspects of environmental impact assessment. Environmental assessment sourcebook update 18*. World Bank, Washington, DC, 1997.

- [62] Z. Q. Wu, M. Masaharu, and Y. Shi, "An improvement to kóczy and hirota's interpolative reasoning in sparse fuzzy rule bases," *Int. J. Approx. Reason.*, vol. 15, no. 3, pp. 185 – 201, 1996.
- [63] Y. Yam and L. Kóczy, "Representing membership functions as points in high-dimensional spaces for fuzzy interpolation and extrapolation," *IEEE T. Fuzzy Syst.*, vol. 8, no. 6, pp. 761–772, Dec 2000.
- [64] Y. Yam, M. L. Wong, and P. Baranyi, "Interpolation with function space representation of membership functions," *IEEE T. Fuzzy Syst.*, vol. 14, no. 3, pp. 398–411, June 2006.
- [65] S. Yan, M. Mizumoto, and W. Z. Qiao, "Reasoning conditions on kóczy's interpolative reasoning method in sparse fuzzy rule bases," *Fuzzy Sets Syst.*, vol. 75, no. 1, pp. 63–71, 1995.
- [66] L. Yang and Q. Shen, "Towards adaptive interpolative reasoning," in *Proc. IEEE Int. Conf. Fuzzy Syst.*, 2009, pp. 542–549.
- [67] ———, "Adaptive fuzzy interpolation and extrapolation with multiple-antecedent rules," in *Proc. IEEE Int. Conf. Fuzzy Syst.*, 2010, pp. 565–572.
- [68] L. A. Zadeh, "Outline of a new approach to the analysis of complex system and decision process," *IEEE T. Syst., Man Cybern.*, vol. 3, no. 1, pp. 28–44, Jan 1973.
- [69] R. Zwick, E. Carlstein, and D. V. Budescu, "Measures of similarity among fuzzy concepts: A comparative analysis," *Int. J. Approx. Reasoning*, vol. 1, no. 2, pp. 221–242, 1987.



Longzhi Yang received his BSc degree in computer science from Nanjing University of Science & Technology, China, in 2003, and the MSc degree in computer science from Coventry University, UK, in 2006. He is currently working towards the PhD degree in computer science at Aberystwyth University, UK. His research interests include truth maintenance system, model-based diagnosis, fuzzy reasoning, data mining, and image processing. His paper, entitled "Adaptive Fuzzy Interpolation and Extrapolation with Multiple-antecedent Rules" has

won the best student paper award at the 19th IEEE International Conference on Fuzzy Systems.



Qiang Shen holds the established Chair in Computer Science and is the Head of the Department of Computer Science at Aberystwyth University, UK. Prof. Shen's research interests include: computational intelligence, fuzzy and qualitative modeling, reasoning under uncertainty, pattern recognition, data mining, and real-world applications of such techniques for intelligent decision support (e.g. crime detection, consumer profiling, systems monitoring, and medical diagnosis). Prof. Shen is currently an associate editor of two premier IEEE

Transactions (Systems, Man and Cybernetics - Part B, and Fuzzy Systems), and an editorial board member of several other leading international journals (including Fuzzy Sets and Systems). He has chaired and given keynote lectures at many international conferences. Prof. Shen has authored 2 research monographs, and over 270 peer-reviewed papers, including one which received an Outstanding Transactions Paper Award from IEEE.